



Owner's Manual

Original Instructions

Wired Controller XE70-33/H

Thank you for choosing this product. Please read this Owner's Manual carefully before operation and retain it for future reference.

If you have lost the Owner's Manual, please contact the local agent or visit www.gree.com or send an email to global@cn.gree.com for the electronic version.

GREE ELECTRIC APPLIANCES, INC. OF ZHUHAI



To Users

Thank you for selecting Gree's product. Please read this instruction manual carefully before installing and using the product, so as to master and correctly use the product. In order to guide you to correctly install and use our product and achieve expected operating effect, we hereby instruct as below:

- (1) This appliance is not intended for use by persons (including children) with reduced physical, sensory or mental capabilities, or lack of experience and knowledge, unless they have been given supervision or instruction concerning use of the appliance by a person responsible for their safety. Children should be supervised to ensure that they do not play with the appliance.
- (2) This instruction manual is a universal manual, some functions are only applicable to particular product. All the illustrations and information in the instruction manual are only for reference, and control interface should be subject to actual operation.
- (3) In order to make the product better, we will continuously conduct improvement and innovation. We have the right to make necessary revision to the product from time to time due to the reason of sales or production, and reserve the right to revise the contents without further notice.
- (4) For personal injury or property loss and damage caused by improper operation such as improper installation and debugging, unnecessary maintenance, violation of related national laws and rules and industrial standard, and violation of this instruction manual, etc., we will bear no liability.
- (5) The final right to interpret for this instruction manual belongs to Gree Electric Appliances, Inc. of Zhuhai.

Contents

1 Safety Notices (Please be sure to abide them)	1
2 Operation Notices	1
3 Instructions to Appearance and Display	3
3.1 LCD of Wired Controller.....	4
3.2 Instruction for LCD of Wired Controller	5
4 Buttons	5
4.1 Silkscreen of Buttons	5
4.2 Instruction for Buttons.....	6
5 Instructions for Status Column	7
6 Installation and Commissioning	10
6.1 Instruction of wired controller.....	11
6.2 Engineering Debugging of Air Conditioner	19
7 Operational Instructions of Air Conditioner	36
7.1 ON/OFF	37
7.2 Setting of Modes.....	37
7.3 Setting of Temperature	38
7.4 Setting of Fan Speed	39
7.5 Setting of Swing Function.....	40
7.6 Setting of Functions	42
7.7 Gate-control Function	49

7.8 Independent Swing*	50
8 Operational Instructions of ERV+DX Coil Unit	52
8.1 ON/OFF	52
8.2 Setting of Modes	53
8.3 Setting of Temperature	54
8.4 Setting of Fan Speed	54
8.5 Setting of Control Modes	55
8.6 Setting of Functions	56
9 Instructions to General Operation.....	58
9.1 Setting of Schedule	58
9.2 Service Hotline	60
9.3 Setting of Language	62
9.4 Setting of Sound	62
9.5 Setting of Date and Time	62
9.6 Long-distance Shielding	62
9.7 Inquiry of Indoor Temperature with One Button	63
10 Display of Errors	63
10.1 Error Code List of ODU	64
10.2 Error Code List of IDU	66
10.3 Code List for Debugging	68
10.4 Code List for Status	69

1 Safety Notices (Please be sure to abide them)



WARNING: If not abide them strictly, it may cause severe damage to the unit or the people.



NOTE: If not abide them strictly, it may cause slight or medium damage to the unit or the people.



This sign indicates that the items must be prohibited. Improper operation may cause severe damage or death to people.



This sign indicates that the items must be observed. Improper operation may cause damage to people or property.



WARNING!

This product can't be installed at corrosive, inflammable or explosive environment or the place with special requirements, such as kitchen. Otherwise, it will affect the normal operation or shorten the service life of the unit, or even cause fire hazard or serious injury. As for the above special places, please adopt special air conditioner with anti-corrosive or anti-explosion function.

2 Operation Notices

- ◆ The power supply for all indoor units must be unified.
- ◆ Prohibit installing the wired controller at wet or sunshine places.
- ◆ Do not knock, throw or frequently disassemble the wired controller.
- ◆ Do not operate the wired controller with wet hands.

- ◆ When the system mode priority is the master-slave mode, in one system network, you must set one indoor unit as the master indoor unit, Other indoor units are slave indoor units .
- ◆ When the system mode priority is the master-slave mode, the operation mode of the system is basing on that of the master indoor unit. The master indoor unit can be set to any mode (including auto mode), while the slave indoor unit can't set to the mode that conflicts with the system mode.
- ◆ When the system mode priority is: Cooling mode is prioritized, heating mode is prioritized, first-set mode is prioritized, or last-set mode is prioritized. The indoor unit can be set to any mode (excluding auto mode). The indoor unit will automatically switch to the system mode, when the operation mode of the indoor unit conflicts with the system operation mode.
- ◆ When the system mode priority is the voting mode (indoor unit's capacity is prioritized / number of indoor units is prioritized). The indoor unit can be set to any mode (excluding the auto mode). The indoor unit will be stopped, when the operation mode of the indoor unit conflicts with the system operation mode after voting.
- ◆ System mode priority defaults to master-slave mode, and only certain units have other system mode priorities.
- ◆ When two wired controllers control one (or more) indoor unit(s), the address of wired controller should be different.

- ◆ Functions with “*” are optional for indoor units. If a function is not included in an indoor unit, wired controller can't set the function, or setting of this function is invalid to the indoor unit.

3 Instructions to Appearance and Display

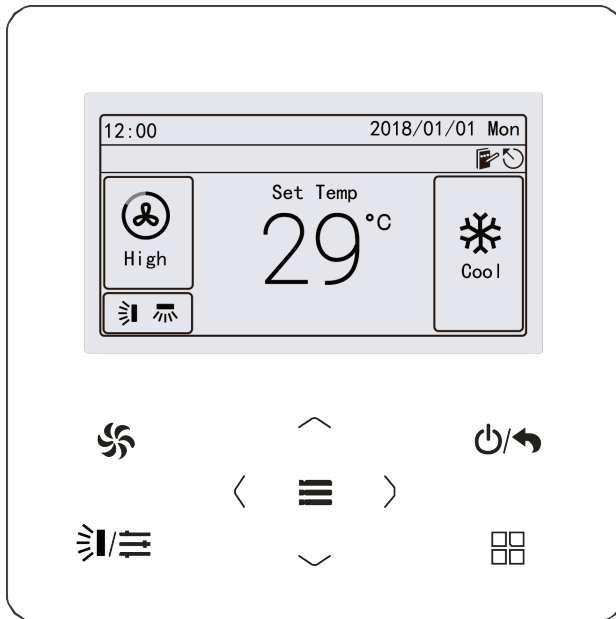

Fig. 3.1 Outline of wired controller

3.1 LCD of Wired Controller

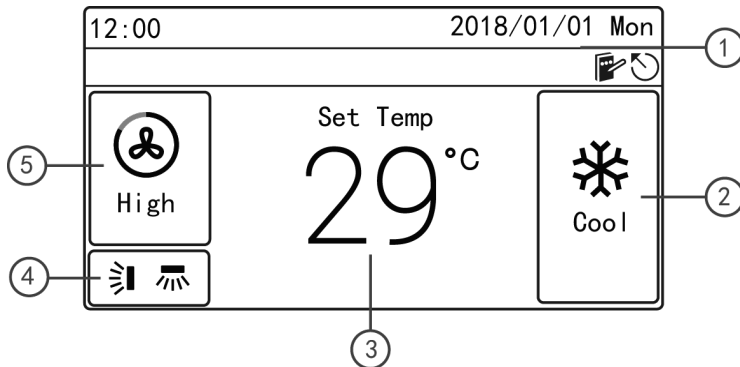

Fig. 3.2 LCD of air conditioner wired controller

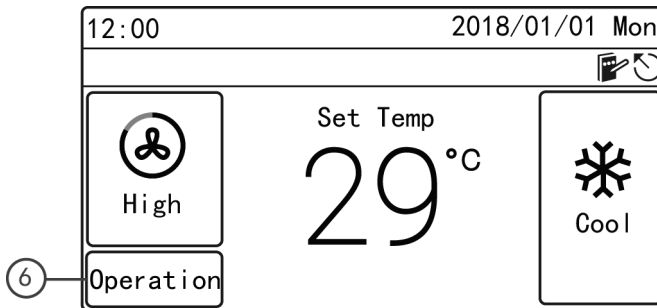

Fig. 3.3 LCD of ERV+DX Coil unit wired controller

3.2 Instruction for LCD of Wired Controller

Table 3.1

No.	Name	Instruction
1	Status	It is for displaying date, time and the activated functional icon
2	Mode	It is for displaying operating mode
3	Temperature	It is for displaying the temperature
4	Swing	It is for displaying the current swing status
5	Fan speed	It is for displaying the fan speed
6	Control mode	It is for displaying the control mode of the ERV+DX Coil unit

4 Buttons

4.1 Silkscreen of Buttons

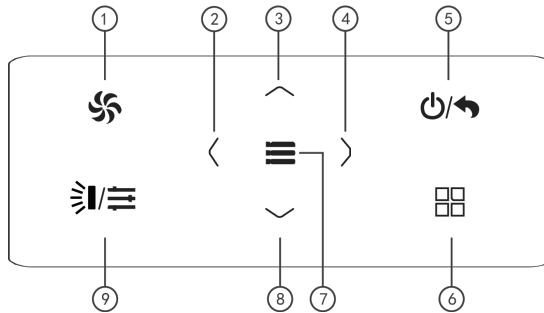

Fig. 4.1 Silkscreen of buttons

4.2 Instruction for Buttons

Table 4.1 Instruction for Buttons









No.	Name	Function
1	Fan	Switch fan speed: Auto, Low, Med. Low, Medium, Med. High, and High
2	Left	Turn page
4	Right	Move the cursor Set and view parameters
3	Up	Set the operating temperature of indoor unit
8	Down	Move the cursor Set and view parameters
5	ON/OFF/Return	Turn on/off the unit and return to the previous page
6	Mode	Switch the operating mode: Auto, Cool, Dry, Fan, Heat, Floor, 3D Heat, etc.
7	Menu/OK	Select mode and confirm parameters
9	Swing/Control	Set the swing status of air conditioner or control mode of ERV+DX Coil system

NOTES:

- ① When the button operation is invalid, the beeper beeps for twice to prompt.
- ② If there is no operation in wired controller for consecutive 20 seconds, the backlight turns off and returns to the homepage.

5 Instructions for Status Column

Table 5.1 Instruction for Status Column of AC

Icon	Name	Instruction
	Master	Display when the current indoor unit connected by the wired controller is master indoor unit (the icon will not be displayed when the wired controller connects to heat recovery unit)
	Group control	Display when one wired controller controls multiple indoor units at the same time
	Slave wired controller	It means the current wired controller is a slave wired controller (address of wired controller is 02)
	Shielding	It means shielding status
	Card pulling	The gate control card is pulled out
	Lock	Lock status
	Invalid operation	Display when the operation is invalid
	Error	Display when error occurs
	Memory	Memory status (when the unit is re-energized after power failure, the indoor unit will resume to the setting status)

Wired Controller XE70-33/H



















Icon	Name	Instruction
	Defrost	Defrosting status of outdoor unit
	Schedule	Display when schedule function is activated
	Clean	The status for reminding of cleaning the filter

Table 5.2 Instruction for Status Column of ERV+DX Coil IDU

Icon	Name	Instruction
	Master	Display when the current indoor unit connected by the wired controller is master indoor unit (the icon will not be displayed when the wired controller connects to heat recovery unit)
	Group control	Display when one wired controller controls multiple indoor units at the same time
	Slave wired controller	It means the current wired controller is a slave wired controller (address of wired controller is 02)
	Shielding	It means shielding status
	Card pulling	The gate control card is pulled out
	Lock	Lock status

Icon	Name	Instruction
	Invalid operation	Display when the operation is invalid
	Error	Display when error occurs
	Memory	Memory status (when the unit is re-energized after power failure, the indoor unit will resume to the setting status)
	Defrost	Defrosting status of outdoor unit
	Schedule	Display when schedule function is activated
	Clean	The status for reminding of cleaning the filter
	Humidification (Some models are with humidification function.)	Humidification function is activated
	Energy recovery	It means the current energy recovery function is valid
	Bypass	It means the current bypass function is valid
	Air discharge	Air discharge mode

6 Installation and Commissioning

Unit:mm

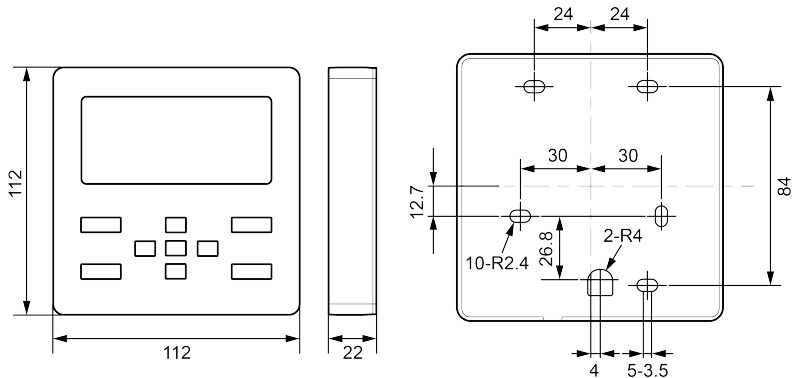

Fig. 6.1 Dimension of Wired Controller

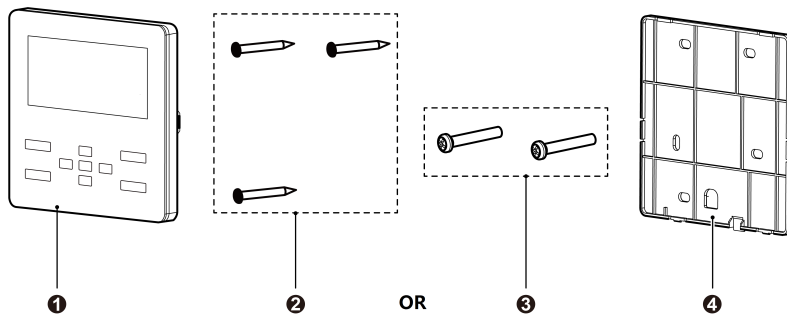

Fig. 6.2 Parts and Components of Wired Controller

No.	1	2	3	4
Name	Panel of wired controller	Tapping screw ST3.9X25 MA	Screw M4×25	Soleplate of wired controller
QTY	1	3	2	1

6.1 Instruction of wired controller

6.1.1 Requirements for model selection of communication wire

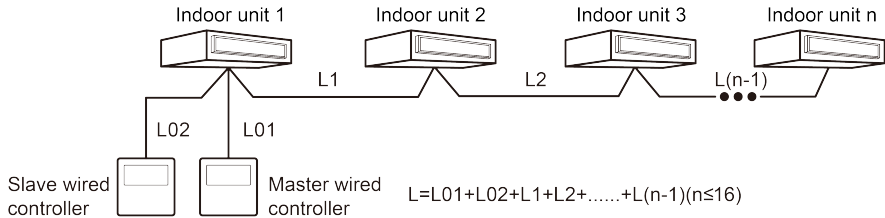

Fig. 6.3 Length of communication wire

Wired Controller XE70-33/H

Wire material type	Total length of communication line between indoor unit and wired controller L (m/feet)	Wire size (mm ² /AWG)	Material standard	Remarks
Light/ Ordinary Polyvinyl chloride sheathed cord. (60227 IEC 52 /60227 IEC 53)	L≤250m (L≤820-1/5feet)	2×0.75 mm ² ~2× 1.25 mm ² (2×AWG18~ 2×AWG16)	IEC 60227-5:2007	(1) Total length of communication line can't exceed 250m (820-1/5feet). (2) The cord shall be Circular cord (the cores shall be twisted together). (3) If unit is installed in places with intense magnetic field or strong interference, it is necessary to use shielded wire.

NOTES:

- ① If the air conditioner is installed in the place with heavy magnetic field, the wired controller must adopt shielded twisted pair.
- ② Communication wire material of wired controller must meet the requirements of this instruction manual. It is not allowed to use the communication wire not in consistent with the requirements of this instruction manual.

6.1.2 Requirements for Installation

- (1) It is not allowed to install the wired controller in the wet place.
- (2) It is not allowed to install the wired controller in the place with direct sunlight.
- (3) It is not allowed to install the wired controller near the high-temperature object or the place is likely to be spattered with water.
- (4) It is not allowed to install the wired controller in the position where faces the window to prevent working error due to the interference of the remote controller with the same model from neighbor.

6.1.3 Requirements for Wired Connection

Network connecting methods between wired controller and indoor unit are as below:

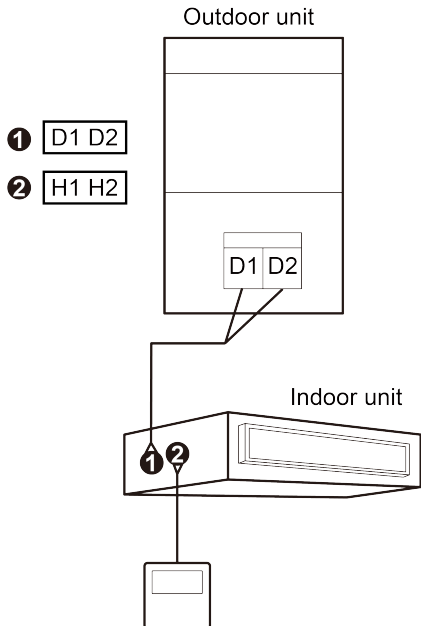

Fig. 6.4 one wired controller controls one indoor unit

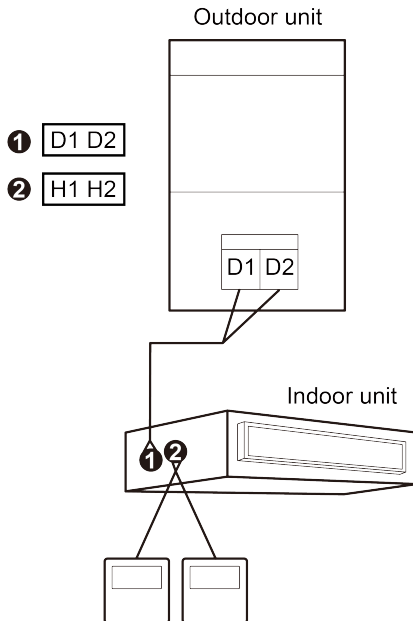

Fig. 6.5 two wired controllers control one indoor unit

- (1) When one (or two) wired controller controls multiple indoor units simultaneously, the wired controller can connect anyone of indoor unit. Quantity of indoor unit controlled by wired controller is not over 16 sets, and the connected indoor unit should be in the network of the same indoor unit. Wired controller should set the group control of quantity of indoor unit, for setting method please see “6.2.2 Setting of Parameters”.
- (2) When two wired controllers control one (or more) indoor unit simultaneously, there must be one master wired controller and one slave wired controller. For setting of master and slave wired controllers please see “6.2.2 Setting of Parameters”.

6.1.4 Installation

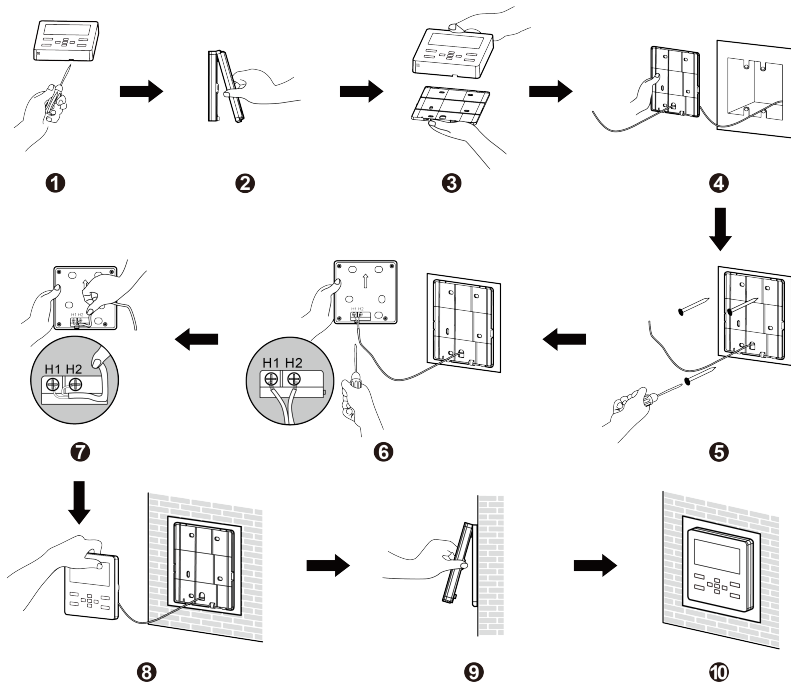

Fig. 6.8 Installation of Wired Controller

Fig. 6.8 shows a simple installation course of wired controller, and the following points should be noted:

- (1) Before installation, please cut off the power supply of indoor unit, it is not allowed to operate with power supply;
- (2) Pull out the 2-core twisted pair inside the installation hole in the wall, and thread the wire through the “□” shape hole in the back of soleplate of wired controller;
- (3) Stick the soleplate of wired controller on the wall, and use tapping screw ST3.9×25 MA or screw M4×25 to fix the soleplate with the installation hole of wall;
- (4) Connect the 2-core twisted pair to wiring terminal H1 and H2, and then tighten the screw;
- (5) Arrange the wires in the back of panel, and then buckle the panel of wired controller with the soleplate of wired controller.

 **NOTE:**

When the wire diameter of the selected communication wire is relatively large and lead to difficulty in threading and arranging the wires in the above point 2 and point 5, you can remove proper length of the protective jacket of communication wire according to actual situation.

6.1.5 Disassembly

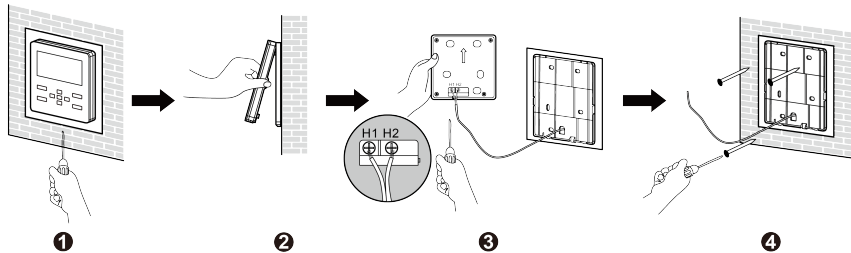

Fig. 6.9 Disassembly of wired controller

6.2 Engineering Debugging of Air Conditioner

6.2.1 Inquiry of Parameters

Parameters can be viewed under both ON and OFF status.

In homepage, press “≡” to enter into menu page, and then select “View” to enter into inquiry page. In the inquiry page, select “Project View” to enter into project view page, as shown below:

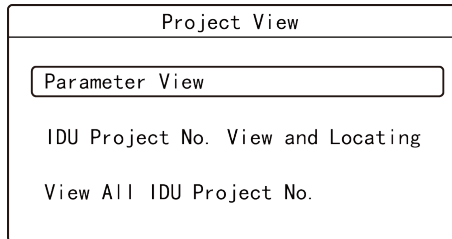

(1) IDU project No. View and Locating

In the project view page, select “IDU Project No. View and Locating” to enter into IDU project No. view and locating page, as shown below, this page displays IDU project number and IDU error.

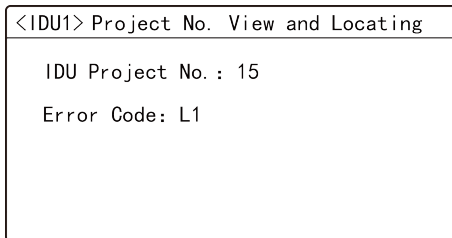

If there are many indoor units, please press “<” or “>” button to switch the indoor unit, it will display corresponding IDU project No. and the current error of IDU; when one indoor unit has more than one error, it will display the error code circularly with an interval of 3 seconds, if there is no error, it will display “Null”.

After entering into IDU project No. viewing and locating page, the current selected indoor unit will beep until quitting the viewing page or switching to the next indoor unit, the selected indoor unit stops beeping.

(2) View All IDU Project No.

In project No. viewing page, select “View All IDU Project No.” to enter into the page, as shown below, user can turn on or turn off the function of viewing all the IDU project No.

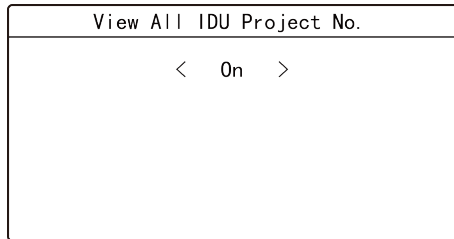

After activating the function of viewing all the IDU project No., all the IDU, wired controller (wired controller will display the IDU project No. circularly in every 3 seconds, and will display according to the project No. from small to large) in the network will display its project No.

After activating the function of viewing all IDU project No., user can enter into this page to turn off the function, or press “/” button in anyone of the wired controller of the network to cancel the display of all IDU project No.

(3) Parameter View

In the project view page, select “Parameter View” to enter into the page, as shown below, user can view the parameters as shown in table 6.1 and table 6.2.

Parameter View	1/12
Wired Controller' s Address: 1	
Number of IDUs: 5	
Master IDU' s Project No. : 3	
Time Left to Clean Filter: 30Day	

When viewing the IDU parameters, if there are many indoor units, please press “<” or “>” button to switch the indoor unit, the interface will display the corresponding parameters of indoor unit, as shown below.

<IDU1>	IDU Parameter View	3/12
IDU Error Log: L1, L4, d3, d4, d6		
Prior Operation: No		
Indoor Temp: 25°C		
Relative Humidity: 65%		

When viewing the ODU parameters, if there are many outdoor units, please press “<” or “>” button to switch the outdoor unit, the interface will display the corresponding parameters of outdoor unit, as shown below.

```
<ODU1> ODU Patameter View 7/12
ODU Static Pressure: 50Pa
ODU Error Log: C2
Outdoor Temp: 30°C
Comp1 Operation Frep: 100Hz
```

When viewing the parameters of air box, if there are many air boxes, press “<” or “>” button to switch the air box, the interface will display the corresponding parameters of outdoor unit, as shown below.

```
<BOX1> Air Box Parameter View 3/12
PM2.5: 40ug/m3
CO2: 600ppm
Temp: 25°C
RH: 65%
```

Table 6.1 List for Viewing Parameters of Air Conditioner

Parameter Name	Range	Parameter Name	Range
Wired Controller's Address	1、2	Number of IDUs	1~16
Master IDU's Project No.	1~255	Time Left to Clean Filter	0~416day
Online IDUs of CAN1	1~100	CAN2 Address	1~255
Max Distribution Ratio	110%、135%、 150%	Cool & Heat Modes	Cool only, Heat Only, Cool & Heat, Fan
IDU Error Log	5 historical errors	Prior Operation	Yes, No
Indoor Temp	-9~99℃	Relative Humidity	20%~90%
Inlet Temp 1	-9~99℃	Outlet Temp 1	-9~99℃
Inlet Temp 2	-9~99℃	Outlet Temp 2	-9~99℃
IDU capacity	IDU capacity and capacity after adjustment	IDU EXV Status	0~20
Fresh Air IDU Output Temp	Actual value	Duct Network Static Pressure	0、20、50、80
ODU Static Pressure	0~999	ODU Error Log	5 historical errors
The following parameters can only be viewed from the master wired controller, they cannot be viewed from the slave wired controller			
Unit Code	0~9, A~Z, a~z,-	Board Code	0~9, A~Z, a~z,-
Outdoor Temp	-30~139℃	Comp1 Operation Freq	0~200Hz
Comp2 Operation Freq	0~200Hz	ODU Fan Operation Freq	0~100Hz

Parameter Name	Range	Parameter Name	Range
Module High Pressure	-40~70°C	Module Low Pressure	-69~38°C
Comp1 Discharge Temp	-30~150°C	Comp2 Discharge Temp	-30~150°C
Comp3 Discharge Temp	-30~150°C	Comp4 Discharge Temp	-30~150°C
Comp5 Discharge Temp	-30~150°C	Comp6 Discharge Temp	-30~150°C
Comp3 Operation Freq	0~200Hz	ODU Heating EXV1	0~48
ODU Heating EXV2	0~48	Subcooler EXV	0~48
Defrosting Temp	-30~139°C	Subcooler Liquid Temp	-30~139°C
Separator Outlet Temp	-30~139°C	Oil Return Temp	-30~139°C
Condenser Inlet Temp	-30~139°C	Condenser Outlet Temp	-30~139°C

NOTES:

- ① Under parameters viewing status, the signal of remote controller is invalid.
- ② When the parameter is invalid, it will display "--".

Table 6.2 View the Parameter List of ERV+DX Coil

Parameter Name	Range	Parameter Name	Range
Wired Controller's Address	1、2	Number of IDUs	1~16
Online IDUs of CAN1	1~100	CAN2 Address	1~255
Max Distribution Ratio	110%、135%、 150%	Cool & Heat Modes	Cool only, Heat Only, Cool & Heat, Fan

Wired Controller XE70-33/H

Parameter Name	Range	Parameter Name	Range
PM2.5	0~1000ug/m ³	CO ₂	400~2000ppm
Temp	-10°C~50°C	RH	0~95%
IDU Error Log	5 historical errors	Prior Operation	Yes, no
Replacement remaining time for primary filter	0-100%	Cleaning remaining time for primary filter	0-100%
Cleaning remaining time for IFD	0-100%	Replacement remaining time for high-efficiency filter	0-100%
Inlet Temp	-9~99°C	Outlet Temp	-9~99°C
Fresh Air Inlet Temp	-9~99°C	Fresh Air Inlet Humidity	20%~90%
Indoor Ambient Temp	-9~99°C	Indoor Ambient Humi	20%~90%
Evaporator Temp	-9~99°C	Indoor Air Outlet Temp	-9~99°C
Positive and Negative Pressure Setting	Positive pressure, negative pressure, balance	Master Air Box	1~255
IDU Capacity	IDU capacity and capacity after adjustment	ODU Static Pressure	0、20、50、80
ODU Error Log	5 historical errors	—	—
The following parameters can only be viewed in the master wired controller, they cannot be viewed from the slave wired controller			
Unit Code	0~9, A~Z, a~z,-	Board Code	0~9, A~Z, a~z,-
Outdoor Temp	-30~139°C	Comp1 Operation Freq	0~200Hz
Comp2 Operation Freq	0~200Hz	ODU Fan Operation Freq	0~100Hz

Parameter Name	Range	Parameter Name	Range
Module High Pressure	-40~70°C	Module Low Pressure	-69~38°C
Comp1 Discharge Temp	-30~150°C	Comp2 Discharge Temp	-30~150°C
Comp3 Discharge Temp	-30~150°C	Comp4 Discharge Temp	-30~150°C
Comp5 Discharge Temp	-30~150°C	Comp6 Discharge Temp	-30~150°C
Comp3 Operation Freq	0~200Hz	ODU Heating EXV1	0~48
ODU Heating EXV2	0~48	Subcooler EXV	0~48
Defrosting Temp	-30~139°C	Subcooler Liquid Temp	-30~139°C
Separator Outlet Temp	-30~139°C	Oil Return Temp	-30~139°C
Condenser Inlet Temp	-30~139°C	Condenser Outlet Temp	-30~139°C

Remark: there are no equipped remote controls for current wired controllers. The remote receiving function is only the reserved function.



6.2.2 Setting of Parameters



Parameters of unit can be set under both ON and OFF status.

In the homepage, press  to enter into the menu page, and then select “set” to enter into the setting page; in the setting interface, select “project set” to enter into the page, as shown below, for the settable parameters please the following Table 6.3 and Table 6.4.

Parameter Setting		1/13
Master Wired Controller	<input checked="" type="radio"/> Master IDU	<input checked="" type="radio"/>
Use Remote	<input checked="" type="radio"/> Prior Operation	<input type="radio"/>
High Ceiling Installation	<input type="radio"/> Link with Fresh Air IDU	<input type="radio"/>
PM2.5 Filter	<input type="radio"/> In °F	<input type="radio"/>



Parameter Setting		2/13
Clear Filter Cleaning Time		
Reset Wifi		
IDU Fan Static Pressure: 5		
Number of IDUs: 8		

Press “” or “” button to switch the option, press and hold the button can switch quickly;

When selecting the right icon “” or “”, press “” button to turn on or turn off the corresponding

Press “” or “” button to turn the page.

6.3 Setting Parameter List of Air Conditioner

Item	Settable range	Default	Remarks
Master Wired Controller	ON, OFF	ON	When it is off, this wired controller is slave wired controller, status column of the homepage displays the icon of slave wired controller "  ", the wired controller can only activate the master wired controller, it does not have the function of setting parameters for other units.
Master IDU	ON, OFF	OFF	Once it is activated, the current IDU is set to be master IDU. When the setting is on, if the system mode priority is the master-slave mode, the status column in homepage will display the icon of master IDU "  "; when the setting is off, master and slave status of the current IDU will not be changed.
Use Remote	ON, OFF	ON	When it is set as OFF, the wired controller cannot receive the remote control signal, only can operate with buttons.
Prior Operation	ON, OFF	OFF	When the power supply is insufficient, it is allowed to turn on the designated IDU as preferential operation, other IDUs should be compulsorily off.

Wired Controller XE70-33/H

Item	Settable range	Default	Remarks
High Ceiling Installation	ON, OFF	OFF	Only applicable to cassette type IDU
Link with Fresh Air IDU	ON, OFF	OFF	After setting the linkage function, the fresh air IDU will automatically turn on or turn off along with the on and off of general IDU, meanwhile, user can manually turn on or turn off the unit. Only applicable to fresh air IDU.
PM2.5 filter*	ON, OFF	OFF	After it is successfully set, adjust the revolving speed to ensure the air volume is close to or the same as the previous air volume. Only applicable to the unit with PM2.5 filter.
In °F	ON, OFF	ON	When it is set as "ON", the temperature unit becomes Fahrenheit, otherwise the unit is degree Celsius.
Clear Filter Cleaning Time	Clear Filter Cleaning Time?		—
Reset WiFi	Reset WiFi?		Only applicable to the unit connected to "G-cloud control".
IDU Fan Static Pressure	1~9	5	—

Item	Settable range	Default	Remarks
Number of IDUs	0: disable this function 1-16: quantity of IDU	1	Set corresponding value according to the connected quantity of IDU.
Angle of Air-return Board	Angle 1 Angle 2 Angle 3	Angle 2	Only applicable to the model with air-return plate.
Cooling temp of Auto Mode	17°C~30°C	25°C	Cooling temperature of Auto mode – heating temperature of Auto mode≥1°C.
Heating temp of Auto Mode	16°C~29°C	20°C	
Cooling Temp of Fresh Air IDU	16°C~30°C	18°C	Only applicable to fresh air IDU.
Heating Temp of Fresh Air IDU	16°C~30°C	22°C	Only applicable to fresh air IDU.
Relative Humidity of Auto Dry*	65%~85%	75%	—
Relative Humidity of Absence*	65%~85%	75%	—

Wired Controller XE70-33/H

Item	Settable range	Default	Remarks
Temp of Absence Mode*	5~10°C	8°C	—
Resume after inserting card	00:No 01:Yes	01:Yes	When it is set as 00, it will keep the status after inserting the gate control card, that is, if it is OFF status when pulling out the card, when inserting the card, it is still OFF status.
Cold air prevention time setting of indoor unit*	180s 300s 420s 600s	180s	Cold air prevention time is the max waiting time from the time turning on the heating mode to the time blowing out the hot wind. The actual waiting time is related to the outdoor ambient temperature. If there is cold air after turning on the heating mode in the actual operation, please consult the professional person to adjust this parameter.

NOTES:

- ① Except for the above parameters, setting interface for other parameter can only be accessed by inputting password.
- ② Under parameter setting status, signal of remote controller is invalid.

Table 6.4 Setting Parameter List of ERV+DX Coil

Item	Settable range	Default	Remarks
Master wired controller	ON, OFF	ON	When it is off, this wired controller is slave wired controller, status column of the homepage displays the icon of slave wired controller “  33

Wired Controller XE70-33/H

Item	Settable range	Default	Remarks
Master Air Box	0-4, ----	----	One master air box can be set, if many master air boxes are set, the latest one should be the master one. When setting it as“--”, it indicates the current main air box is canceled. No.0 air box can't be set as the main air box.
Display Status of LED	OFF, constantly ON	Constantly ON	Each air box should be set;
PM2.5 Sensor On/Off	OFF, constantly ON	OFF	Each air box should be set;
Air Box On/Off	ON/OFF	ON	Each air box should be set;
Positive and Negative Pressure Setting	Balance, positive, negative	Balance	00: balance fan speed, the fan speed of ERV+DX Coil motor and air-return motor is the same as the setting fan speed of wired controller; 01: positive pressure mode, setting of fan speed of ERV+DX Coil motor and air-return motor is automatically switched according to the logic of positive pressure; 02: negative mode, setting of fan speed of ERV+DX Coil motor and air-return motor is automatically switched according to the logic of negative pressure.



Item	Settable range	Default	Remarks
Outdoor Air Pollution Degree	01: very good 02: good 03: light pollution 04: medium pollution 05: high pollution 06: severe pollution	02	Set the outdoor pollution level according to the pollution degree of different regions. It is used for calculating the time for reminding washing and replacing filter.
Indoor Air Quality Target	01、02	02	When in auto control mode, this setting is used for controlling the ON/OFF and standby of ERV+DX Coil unit; for specific value please the master control logic;
Auto Control Sensor	PM2.5, CO ₂ , Common	CO ₂	Make sure to conduct auto control according to target of which sensor
Linkage Method	CAN、HBS	CAN	CAN1 linkage: activation of IDU of anyone of air conditioner or ERV+DX Coil unit in CAN1 network; turning off IDU of all the air conditioners and ERV+DX Coil units; HBS linkage: activation of IDU of anyone of air conditioner or ERV+DX Coil unit under the same wired controller; turning off IDU of all the air conditioners and ERV+DX Coil units.

Item	Settable range	Default	Remarks
Defrosting Fresh Air	Current Fan Fpeed, Lowest Fan Fpeed, Fan Stop Unit	Lowest Fan Fpeed	Set the operating fan speed of ERV+DX Coil unit during defrosting period.
Auto Control Method*	Comfort, Energy-saving	Comfort	Only when the “setting of auto control sensor” is set as “multiple” the setting becomes valid;
Reset WiFi	Reset Wifi?	Not reset	Only applicable to the unit connected with “G-cloud controller”.
Number of IDUs	0: disable this function 1-16: quantity of IDU	1	Set corresponding value according to the quantity of connected IDU.

NOTE:

There is no equipped remote controller for ERV+DX Coil wired controllers. The remote receiving function is only the reserved function.

7 Operational Instructions of Air Conditioner

If one wired controller connects with IDU of multi VRF unit and ERV+DX Coil system simultaneously, click “” or “” button in the homepage can switch the control interfaces of IDU of multi VRF unit and ERV+DX Coil system.

7.1 ON/OFF

Press “” button in the homepage to start up the air conditioner.

Press “” button again to stop the operation of air conditioner.

ON/OFF interface is as shown as Fig. 7.1 and 7.2.

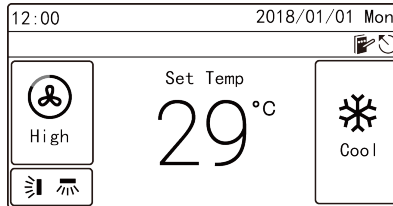

Fig. 7.1 Unit-ON interface

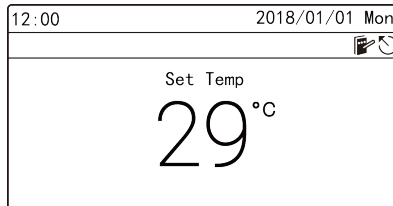



Fig. 7.2 Unit-OFF interface

7.2 Setting of Modes



Under ON status, each time pressing the “” button in the homepage, the mode will be switched as the following order circularly:

Auto-> Cool -> Dry -> Fan -> Heat ->Floor ->3D Heat -> Space -> Auto

NOTES:

- ① The supporting modes differs due to different models, the wired controller will automatically select the setting range of mode according to model of IDU;
- ② Only the master IDU in the master-slave mode can set the Auto mode (It is not applicable to heat recovery units);
- ③ Instructions for mode switch:
 - a) For heat recovery units, anyone of IDU can switch mode arbitrarily;
 - b) For other units, when the system mode priority is the master-slave mode, the system mode will be subject to the mode of master IDU; the master IDU can switch mode arbitrarily, while the slave IDU cannot switch to the mode which may conflict to the mode of master IDU; when the master IDU changes the mode and leads to confliction of modes between slave IDU and the system, the operating mode of slave IDU will automatically switch to the system mode.

7.3 Setting of Temperature



Under ON status, press “” or “” button, the set temperature will increase or decrease with the unit of 1°C; when press and hold these two buttons, the temperature will increase or decrease with the unit of 1°C in every 0.3 second.

Under Cool ,Fan, Heat, Floor, 3D Heat and Space modes, the temperature setting range is 16°C~30°C.

Under Dry mode, the temperature setting range is 12°C, 16°C~30°C. Under Dry

mode, when the temperature is 16°C, press the “” button twice can decrease the temperature to 12°C (when the heating Save function is activated, the Dry temperature should not be adjusted to 12°C, the range is “lower limit value of Save temperature” ~30°C).

NOTES:

- ① When the Absence function is activated, the set temperature should not be adjusted via “” or “” button.
- ② Under Auto mode, it cannot enter into temperature setting interface, user can only set the cooling and heating temperature of Auto mode in the project parameters setting page.
- ③ When the wired controller connects to Fresh air IDU, the homepage will not display the set temperature, while the temperature displaying area will display the code of Fresh air IDU “FAP”, and the temperature setting interface cannot be accessed, user can only set the cooling or heating air-out temperature in the parameter setting page.

7.4 Setting of Fan Speed

Under ON status, pressing “” button on homepage can switch fan speed circularly in the following order:

Auto->Low->Med. Low->Medium-> Med. High ->High-> Auto

NOTES:

- ① Under Dry mode, low fan speed is set automatically. Fan speed cannot be adjusted.
- ② If wired controller is connected to fresh air indoor unit, high fan speed is set automatically. Pressing "🌀" button cannot change the fan speed.
- ③ If auto fan speed is set, indoor unit will change fan speed automatically according to indoor ambient temperature.

7.5 Setting of Swing Function

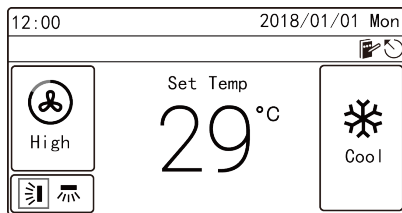

Under ON status, the up and down swing function and left and right swing function are settable.



(1) Up and down swing function:

Up and down swing function has two modes: simple swing and fixed frame swing. Select "U&D Swing Position" in the functional page, and then press "≡" button can switch between simple swing mode and fixed frame swing mode.

Under ON status, press "🌀/≡" button in the homepage to enter into swing setting:

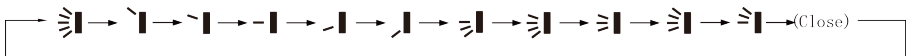

- 1) When it is set as simple swing, press “ \wedge ” or “ \vee ” button can turn on or turn off the up and down swing mode, after finishing setting, press “” button can save the setting.
- 2) When it is set as fixed frame swing, press “ \wedge ” or “ \vee ” button can switch the swing mode according to the order of the following figure circularly, after finishing setting, press “” button can save the setting.



(2) Left and right swing function*:

Left and right swing function has two modes: simple swing and fixed frame swing. Select “L&R Swing Position” in the functional page, and then press “” can switch between simple swing mode and fixed frame swing mode.





Under ON status, press “/” button in the homepage to enter into swing setting, press “ \langle ” or “ \rangle ” button to switch to the setting of left and right swing:

- 1) When it is set as simple swing, press “ \wedge ” or “ \vee ” button can turn on or turn off the left and right swing, after finishing the setting, press “” button to save the setting.
- 2) When it is set as fixed frame swing, press “ \wedge ” or “ \vee ” button can switch the swing mode according to the order of the following figure circularly, after finishing setting, press “” button can save the setting.



7.6 Setting of Functions



Under menu page, select “Func” to enter into functional setting page, as shown below.

Switch the option via “” or “” button, press “” button can turn on or turn off corresponding function. If the left of certain function displays “”, it means the function is turned on, if it displays “”, it means the function is turned off.

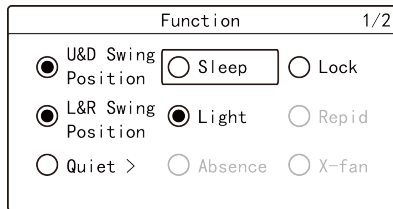
When the option (Quiet, Air, Clean, Save) with “>” is selected, press “” button will enter into the setting interface of corresponding function.



NOTES:

- ① If the function under certain circumstances is invalid, it will display gray, press “” or “” button will skip over this function.
- ② After lock function is activated, it will automatically return to homepage, and any button operation in homepage become invalid, only operate according to the prompts can unlock the function.

Introduction to Functions:

Sleep: this function can make the IDU enters into sleep mode, the IDU will operate according to the preset sleeping temperature curve to create a comfortable sleeping environment and improve sleeping quality. The sleep function can only be activated under Cool, Dry, Heat, 3D Heat or Space mode.

Lock: under lock status, any button operation are invalid, user should operate according to the prompt to unlock the function.

Light: this function can set the ON and OFF of light in light plate of IDU.

Rapid: it is used to fast increase or decrease temperature to the set value when starting the unit. The fast function can only be activated under Cool or Heat mode.

Absence: this function is used for maintaining the indoor ambient temperature and ensuring fast heating after starting the unit. The Absence function can only be activated under Heat mode.

X-fan: it is used for removing the water in the evaporator of IDU after turning off the unit to prevent mildew. The dry function can only be activated under Cool or Dry mode.

Health*: it can turn on or turn off health function to control the air purification module which can purify air. This function cannot be used under Floor mode.

12-Drying: this function can only be activated under Dry mode, after it is activated, the set temperature of Dry mode becomes 12°C.

E-heater*: under Dry mode, in order to prevent the air-out temperature is too low,

it is allowed to turn on the auxiliary electric heating to increase the air-out temperature; under Heat and 3D Heat mode, it is allowed to turn on the auxiliary electric heating to improve the heating efficiency. Turn off the auxiliary electric heating under Heat and 3D Heat mode can save energy.





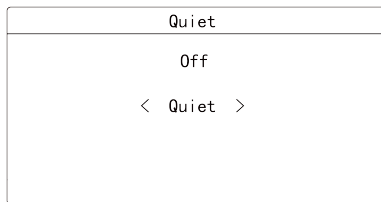

Turbo: it is used to turn on the highest fan speed, after turning on the function, fan speed in the homepage displays turbo.

7.6.1 Setting of Quiet Function

Quiet: it is used for reducing the noise of IDU to achieve quiet effect. The quiet function has two modes: quiet and auto quiet, which only be valid under Auto, Cool, Dry, Fan, Heat, 3D Heat, and Space modes.

Under functional page, select “Quiet” or “Auto Quiet” to enter into setting interface of quiet function, as shown below:



Press “” or “” button to switch the option, when selecting the first option, press “” or “” button to turn on or turn off, when selecting the second option, press “” or “” button to switch “Quiet” and “Auto Quiet”, and then press “” button to save the setting and return to the previous page.

NOTES:

- ① When the quiet function is activated, fan speed of IDU is quiet fan speed, the fan speed will be decreased to reduce the noise of indoor fan.
- ② When the auto quiet function is activated, the indoor unit will automatically change the fan speed according to the indoor ambient temperature, when the indoor ambient temperature reaches the set temperature, it will operate under quiet fan speed.

7.6.2 Setting of Air Function*

Air function: improve the air quality to make the indoor air fresh through adjusting the indoor fresh air volume.

In the functional page, select "Air" to enter into the setting page of air function, as shown below:

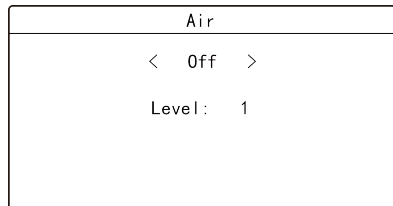

Press “” or “” button to switch option, when selecting the first option, press “” or “” button to turn on or turn off, when selecting the second option, press “” or “” button to turn on or turn off.

“)” button to adjust the air level 1~10, and then press “≡” button to save the setting and return to the previous page.

NOTES:

- ① Air function is applicable only to units with air function and installed with fresh air electric valve (fresh air valve in short).
- ② Air level is related to the opening time of fresh air valve in a certain time (60 minutes). Please see the table below. Opening time of fresh air valve indicates the first N minutes within a certain time. For example: if air degree is set to 1, unit starts to count the time and fresh air valve is open. 6 minutes later, fresh air valve is closed while unit continues operating. When the unit counts to 60 minutes, it will restart counting and fresh air valve is open. 6 minutes later, fresh air valve is closed. Unit operates circularly like this.

Air Level	1	2	3	4	5	6	7	8	9	10
Time for opening of fresh air valve	60/6	60/12	60/18	60/24	60/30	60/36	60/42	60/48	60/54	Constantly open
NOTE: the time in the table means: operating time of unit (minute)/opening time of fresh air valve during the operating period of unit (minute)										







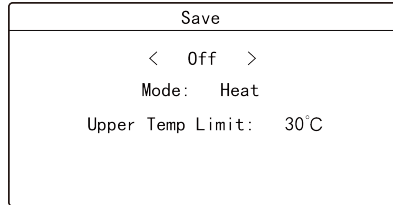

7.6.3 Setting of Save Function

Save: through setting the lower limit value of set temperature for Cool, Dry, modes and upper limit of set temperature for Heat, 3D Heat, Space modes, to make the air conditioner operate in a smaller temperature range, so as to achieve energy

conservation.

In the functional page select “Save” to enter into Save function setting page, as shown below:



Press “” or “” button to switch option, when selecting the first option, press “” or “” button to turn on or turn off; when selecting the second option, press “” or “” button to switch the mode; when selecting the third option, press “” or “” button to switch lower limit value of temperature or upper limit value of temperature, and then press “” button to save the setting and return to the previous page.

When activating the Save function under Cool, Dry modes, the set temperature in homepage should not be lower than the lower limit of Save temperature; when activating the Save function under Heat, 3D Heat, and Space mode, the set temperature in homepage should not be higher than the upper limit of Save temperature.

7.6.4 Setting of Filter Clean Reminder

Filter Clean Reminder: Air conditioner can record its running time and when it

reaches to a certain time, unit can remind user to clean filter. A dirty filter will cause poor cooling and heating effect, malfunction or even generate bacteria.

On the function interface, select "Clean" to enter the setting of filter cleaning reminding function, as shown below:

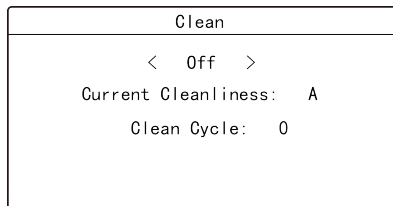

Press “ \wedge ” or “ \vee ” button to switch to a different selection. When selecting the first item, press “ \langle ” or “ \rangle ” to select ON or OFF. When selecting the second item, press “ \langle ” or “ \rangle ” to switch to a cleaning degree of the current environment (A, B, C). When selecting the third item, press “ \langle ” or “ \rangle ” to adjust the clean cycle. The range of filter clean cycle is 0~9. Press “ \equiv ” to save the setting and return to the previous page.

Filter cleaning reminding time is related to the cleaning degree of current environment and the clean cycle. There are 4 types of filter cleaning condition:



- (1) Filter cleaning reminder is OFF;
- (2) Light pollution: Cleaning degree of current environment is “A”. When clean cycle is “0”, the accumulative running time is 5500 hours. Every increase of “1” indicates an increase of 500 hours in running time. When clean cycle is “9”, the accumulative running time is 10000 hours;

- (3) Medium pollution: Cleaning degree of current environment is “B”. When clean cycle is “0”, the accumulative running time is 1400 hours. Every increase of “1” indicates an increase of 400 hours in running time. When clean cycle is “9”, the accumulative running time is 5000 hours;
- (4) Severe pollution: Cleaning degree of current environment is “C”. When clean cycle is “0”, the accumulative running time is 100 hours. Every increase of “1” indicates an increase of 100 hours in running time. When clean cycle is “9”, the accumulative running time is 1000 hours;

NOTE:

When cleaning time is up, icon “” will be displayed on status bar and a reminder box will pop up on homepage to remind user. Press "Done" or "Ignore" to cancel the display. Meanwhile, the accumulative time for "Filter clean reminder" is reset and starts counting again.

7.7 Gate-control Function

When there is Gate-control System, user can insert a card to turn on the unit or pull off a card to turn off the unit. When the card is re-inserted, the unit will recover the operation as state in memory. When the card is pulled off (or improperly inserted), “” icon will show, neither remote control nor operation of wired controller will be effective and icon “” will be flickering.

NOTE: This model cannot be connected with gate control system on its own because it cannot detect gate control signal directly. To realize gate control display and gate

control function, it has to be used with wired controller that includes gate control signal detecting function (used as master and slave wired controller).

7.8 Independent Swing*

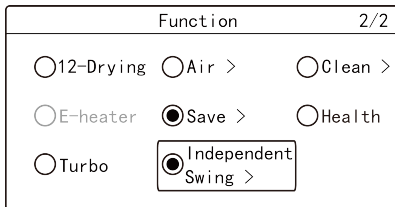
In the homepage, press “

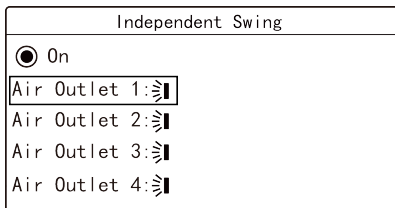

The screenshot shows a menu titled "Function" with a page indicator "2/2". It contains several radio button options: "12-Drying", "Air >", "Clean >", "E-heater", "Save >" (which is selected), "Health", and "Turbo". A red box highlights the "Independent Swing >" option.

After activating the option of independent swing function, select “Independent Swing” in the functional page to enter into the setting page, as shown below.





In the independent swing page, press “

50

- ③ Turn off the independent swing function can resume to the original setting of up and down swing.
- ④ Only the wired controller connects to the unit with independent swing function can the wired controller set the independent swing function.
- ⑤ The above instructions of the independent swing function are only applicable to the unit with independent swing function with four air outlets. When the wired controller connects to the unit with independent swing function with two air outlets, the setting and display of “Air Outlet 3” and “Air Outlet 4” will be disable, and “Air Outlet 1” and “Air Outlet 2” can not be set as closed status. Besides, the position of up and down swing in homepage will display the independent swing icon “” to instead.

8 Operational Instructions of ERV+DX Coil Unit

If one wired controller connects with IDU of multi VRF unit and ERV+DX Coil system simultaneously, click “” or “” button in the homepage can switch the control interfaces of IDU of multi VRF unit and ERV+DX Coil system.

8.1 ON/OFF

Press “” button in the homepage to turn on the ERV+DX Coil unit.

Press “” button again to stop the operation of the ERV+DX Coil unit.

Interface for turning on and turning off the unit please see Fig. 8.1 and Fig. 8.2.

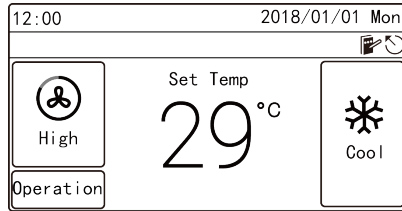

Fig. 8.1 Unit-ON Interface

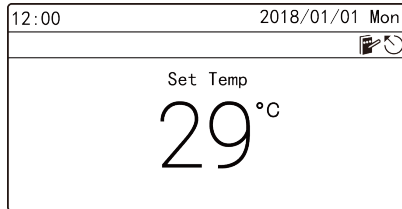



Fig. 8.2 Unit-OFF Interface

8.2 Setting of Modes

Under ON status, each time pressing the  button in the homepage, the mode will be switched as the following order circularly:



Cool -> Dry -> Fan -> Heat -> Cool

NOTES: instructions for mode switch:

- a) For the Heat Recovery unit, anyone of IDU can switch mode arbitrarily;

- b) For other units, the system mode will be subject to the mode of master IDU; the master IDU can switch mode arbitrarily, while the slave IDU cannot switch to the mode which may conflict to the mode of master IDU; when the master IDU changes the mode and leads to confliction of modes between slave IDU and the system, the operating mode of slave IDU will automatically switch to the system mode.

8.3 Setting of Temperature

Under Cool, Dry, Fan and Heat modes, press “” or “” button in ON status, the set temperature will increase or decrease with the unit of 1°C; when press and hold these two buttons, the temperature will increase or decrease with the unit of 1°C in every 0.4 second.

Setting range of temperature: 16°C~30°C.

8.4 Setting of Fan Speed

Under ON status, press “” button in the homepage, the fan speed will switch circularly according to the following order:

Auto->Low->Med. Low->Medium->Med. high->high-> Auto

NOTES:

- ① When the fan speed of IDU is adjusted to auto, the IDU will automatically change the fan speed according to the indoor ambient temperature to make the indoor ambient temperature more stable and comfortable.
- ② Only when the control mode is set as auto can the auto fan speed be valid.
- ③ Fan and control mode of ERV are bound.

8.5 Setting of Control Modes

Under on status, the unit will change in the sequence of auto→linkage→operation circularly after pressing “” button.

Auto control mode: when turning on the unit, ERV+DX Coil will be started up or stay at the standby status according to the air quality detected by the air box; when turning off the unit, the unit will stop operation.

Linkage control mode: when turning on the unit, ERV+DX Coil will be started up or stay at the standby status according to the on/off of the indoor unit of linked VRF unit. when turning off the unit, the unit stops operation.

Operation control mode: when turning on the unit, ERV+DX Coil operates continuously; when turning off the unit, the unit stops operation.

NOTES:

- ① Under HBS linkage mode, “linkage” can be started up only when the ERV+DX Coil and the general air conditioning indoor unit under the same

HBS network are existed. At this time, ERV+DX Coil will be started up or stay at the standby status according to the on/off of indoor unit under the HSB network; once “linkage” is started up under CAN linkage mode, ERV+DX Coil will be started up or stay at the standby status according to the on/off of indoor unit under the CAN network.

- ② Auto control mode can be started up only when the air box is existed.

8.6 Setting of Functions

Under menu page, select “Func” to enter into functional setting page, as shown below.

Switch the option via “

NOTES:

- ① If the function under certain circumstances is invalid, it will display gray, press “

56

Introduction to Functions:

Humidification*: this function can set the ON and OFF of humidity function of IDU.

Free Cooling: after this function is activated, when the outdoor temperature is lower than the set temperature, it will bring fresh air to lower the indoor temperature, and reduce cooling power consumption to reach energy-saving effect.

Free Cooling at night: after this function is activated, when the system shutdown at night (both the air conditioner and ERV+DX Coil unit are turned off), if the outdoor temperature is lower than the indoor temperature, it will turn on the ERV+DX Coil unit to intake fresh air and lower the indoor temperature, and maintain the indoor temperature in a low value in the next day morning, so as to achieve energy conservation. After it is activated, the start time and finish time should be set.

Lock: under lock status, any button operation are invalid, user should operate according to the prompt to unlock the function.

Health*: it can turn on or turn off health function.

Energy-recovery mode: when the indoor and outdoor temperature difference is relatively large, it will adopt the energy-recovery core to reclaim the air discharge energy to conduct precooling or preheating for the fresh air, so as to achieve energy conservation.

By-pass mode: when the indoor and outdoor temperature difference is relatively small, there is no need to reclaim the air discharge energy, the discharged air will go through the by-pass duct, which has smaller wind resistance and can reduce the

energy efficiency of fan.

Air Discharge mode: when the outdoor temperature is extremely low, in order to prevent condensation or frost of whole unit, it will stop intaking fresh air and only conduct air discharge.

Auto mode: auto mode is a kind of fresh wind mode which is based on the Fresh Air Inlet Temp, Indoor Ambient Temp as well as related Fresh Air Inlet Humidity.

9 Instructions to General Operation

9.1 Setting of Schedule

In the homepage, press “☰” button to enter into the menu page, and then select “Schedule” to enter into the schedule page, as shown below. The left side of schedule displays “●” means this schedule function is turned on, when it displays “○” means the schedule function is turned off.

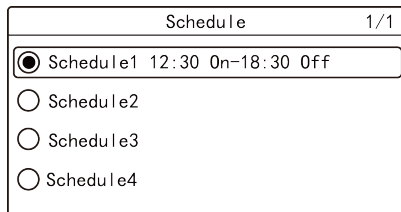

In the schedule page, press “^” or “v” button to switch the options, select “Schedule1” or “Schedule2” or “Schedule3” or “Schedule4” to enter into the setting page of specific schedule, as shown below (take schedule 1 as example).

In order to ensure the precision of time, before setting the schedule, please check if the system time has been set as the current date and time, if the date and time is not correct, please set the date and time in the “Date&Time” setting page.

Schedule 1	
<input checked="" type="radio"/> Enable	Cool
<input type="radio"/> 08:30 On	27°C
<input type="radio"/> 17:00 Off	High
<input type="radio"/> Repeat: Everyday	

In the schedule 1 page, press “ \wedge ” or “ \vee ” button to switch the option, when selecting the first option, press “ \equiv ” button to change schedule 1 to be enable or not; when selecting other option, press “ \equiv ” button to enter into corresponding setting page.

The mode, set temperature and fan speed can be set for the ON status of unit after entering into the setting page of mode, temperature and fan speed.

If user only wants to activate the unit on certain time, only the schedule ON time should be set; if user only wants to turn off the unit on certain time, only the schedule OFF time should be set; if both the turning on and turning off time should be set, the schedule ON and schedule OFF time can be set. Setting page of schedule ON time is shown as below, in the setting page, press “ \wedge ” or “ \vee ” button to switch options, press “ \langle ” or “ \rangle ” button to turn on, turn off or adjust the time, finally press “ \equiv ” button to save the setting and return to the previous page.

On Time	
<	Enable >
Hour:	12
Minute:	30

In the schedule 1 page, select “repeat” to enter into the following setting page, it can set the schedule valid times; press “^” or “v” button can switch the options, press “≡” button can confirm or cancel corresponding option, press “⏻/↶” button can save the setting and return to the previous page.

Schedule-Repeat	
<input checked="" type="radio"/> Everyday	<input type="radio"/> Thursday
<input type="radio"/> Monday	<input type="radio"/> Friday
<input type="radio"/> Tuesday	<input type="radio"/> Saturday
<input type="radio"/> Wednesday	<input type="radio"/> Sunday

NOTE:

If the time format is set as 12 hour-clock, the time in all schedule pages will be displayed in 12-hour clock with an AM/PM indicator.

9.2 Service Hotline

In the View page, select “Hotline” to enter into inquiry page of service hotline, through which can view the “local after-sales telephone number” and “national

service hotline”.

(1) National Service Hotline

National service hotline page includes related information and service hotline of Gree Electric Appliances, Inc. of Zhuhai.

(2) Local After-sales Tel.

(3) Select “Local After-sales Tel.” to enter into the viewing and setting page of local after-sales telephone number, as shown below:

Local Aftersales Tel	
Tel1:	4008365315 Clear
Tel2:	Set First

When the local after-sales telephone number has not been set, there is no telephone number displaying; if the phone number is set, there will display the number. After selecting “please set” or the phone number, press “” button will enter into the next page to set the phone number.

After setting the phone number, select “clear” and press “” button can clear out the corresponding phone number.

Note: in the local after-sales telephone number page, there are two phone numbers can be set, which can let user to find the number quickly and contact the local after-sales service dealer for help.

9.3 Setting of Language

In the setting page, select “Language” to enter into language setting page, Chinese and English version can be set

9.4 Setting of Sound

In the setting page, select “Sound” to enter into voice setting page, the voice of button of wired controller can be turned on or turned off.

9.5 Setting of Date and Time

In the setting page, select “Date & Time” to enter into the setting page to set date and time or set time format.

Select “Time format” to enter into the setting page to set that the time in all interfaces is displayed in either 24 hour-clock or 12 hour-clock with an AM/PM indicator.

Select “Set time” to enter into the setting page to set date and time.

9.6 Long-distance Shielding

Long-distance shielding function: long-distance monitoring or centralized controller can shield the remote control or button operation function of wired controller to disable the operating, so as to achieve long-distance control.

The long-distance shielding function consists of full shielding and partial shielding. When conducting full shielding, all the remote control or button operation of

wired controller are invalid. When conducting partial shielding, the remote control and button operation of wired controller for the shielded functions are invalid.

When the long-distance monitoring or centralized controller conducts long-distance shielding to the wired controller, the “

9.7 Inquiry of Indoor Temperature with One Button

In the homepage, after pressing and holding “

10 Display of Errors

If malfunction occurs when system is running, wired controller will display error icon “

NOTE: If error occurs, please turn off the unit and send for professionals to repair.

10.1 Error Code List of ODU

Error Code	Content	Error Code	Content
E0	Outdoor Unit Error	J9	System Pressure Under-Ratio Protection
E1	High Pressure Protection	JA	Protection of Abnormal Pressure
E2	Discharge Low Temperature Protection	JC	Protection of Water Flow Switch
E3	Low Pressure Protection	JL	Protection of Low High-pressure
E4	Excess Discharge Temperature Protection of Compressor	JE	Oil Return Pipe is Blocked
Ed	Low Temperature Protection of Driver Module	JF	Oil Return Pipe is Leaking
F0	Bad Performance of the Outdoor Mainboard	JJ	Low Water-in Temperature Protection
F1	High Pressure Sensor Error	b1	Outdoor Ambient Temperature Sensor Error
F2	Inlet Tube Temperature Sensor Error of Plate Type Heat Exchanger	b2	Defrosting Temperature Sensor 1 Error
F3	Low Pressure Sensor Error	b3	Defrosting Temperature Sensor 2 Error
F4	Outlet Tube Temperature Sensor Error of Plate Type Heat Exchanger	b4	Subcooler Liquid-out Temperature Sensor Error
F5	Compressor 1 Discharge Temperature Sensor Error	b5	Subcooler Gas-out Temperature Sensor Error
F6	Compressor 2 Discharge Temperature Sensor Error	b6	Gas-liquid Separator Inlet Temperature Sensor Error
F7	Compressor 3 Discharge Temperature Sensor Error	b7	Gas-liquid Separator Outlet Temperature Sensor Error
F8	Compressor 4 Discharge Temperature Sensor Error	b8	Outdoor Humidity Sensor Error
F9	Compressor 5 Discharge Temperature Sensor Error	b9	Heat Exchanger Gas-out Temperature Sensor Error

Error Code	Content	Error Code	Content
FA	Compressor 6 Discharge Temperature Sensor Error	bA	Oil-return Temperature Sensor Error
FC	Compressor 2 Current Sensor Error	bH	System Clock Malfunction
FL	Compressor 3 Current Sensor Error	bE	Malfunction of Entry Tube Temperature Sensor of Condenser
FE	Compressor 4 Current Sensor Error	bF	Malfunction of Exit Tube Temperature Sensor of Condenser
FF	Compressor 5 Current Sensor Error	bJ	High and Low Pressure Sensors are Connected Inversely
FJ	Compressor 6 Current Sensor Error	bP	Oil-return 2 Temperature Sensor Error
FP	Malfunction of DC motor	bU	Oil-return 3 Temperature Sensor Error
FU	Compressor 1 Top Temperature Sensor Error	bb	Oil-return 4 Temperature Sensor Error
Fb	Compressor 2 Top Temperature Sensor Error	bd	Air-in Temperature Sensor Error of Subcooler
Fd	Mode Exchanger Outlet Pipe Temperature Sensor Error	bn	Liquid-in Temperature Sensor Error of Subcooler
Fn	Mode Exchanger Inlet Pipe Temperature Sensor Error	by	Water-out Temperature Sensor Error
Fy	Water-in Temperature Sensor Error	P0	Compressor Drive Board Error
J1	Compressor 1 Over-current Protection	P1	Compressor Drive Board Malfunction
J2	Compressor 2 Over-current Protection	P2	Protection of Compressor Drive Board Power Supply
J3	Compressor 3 Over-current Protection	P3	Protection of Compressor Drive Board Module Reset
J4	Compressor 4 Over-current Protection	H0	Error of Fan Drive Board
J5	Compressor 5 Over-current Protection	H1	Malfunction of Fan Drive Board
J6	Compressor 6 Over-current Protection	H2	Protection of Fan Drive Board Power Supply

Wired Controller XE70-33/H

Error Code	Content	Error Code	Content
J7	4-way Valve Blow-by Protection	GH	PV DC/DC Protection
J8	System Pressure Over-Ratio Protection	—	—

10.2 Error Code List of IDU

Error Code	Content	Error Code	Content
L0	Indoor Unit Error	dL	Outlet Air Temperature Sensor Error
L1	Indoor Fan Protection	dE	Indoor Unit CO ₂ Sensor Error
L2	E-heater Protection	db	Special Code: Field Debugging Code
L3	Water Full Protection	dn	Swing Assembly Error
L4	Wired Controller Power Supply Error	dy	Water Temperature Sensor Error
L5	Anti-Frosting Protection	y1	Inlet Pipe Temperature Sensor 2 Error
L6	Mode Conflict	y2	Outlet Pipe Temperature Sensor 2 Error
L7	No Master Indoor Unit Error	y3	Middle Tube Temperature Sensor 2 Error
L8	Power Insufficiency Protection	y7	Fresh Air Inflow Temperature Sensor Error
L9	Quantity Of Group Control Indoor Units Setting Error	y8	Indoor Air Box Sensor Error
LA	Indoor Units Incompatibility Error	y9	Outdoor Air Box Sensor Error
LH	Low Air Quantity Warning	yA	IFD error
LC	Outdoor-Indoor Incompatibility Error	yH	Fresh Air-out Sensor Error
LF	Shunt Valve Setting Error	yC	Air-return Inlet Sensor Error

Error Code	Content	Error Code	Content
LJ	Wrong Setting of Function DIP Switch	yL	Air-return Outlet Temperature Sensor Error
LP	Zero-crossing Malfunction of PG Motor	yE	High Liquid Level Switch Error
LU	Inconsistent Branch of Group-controlled Indoor Units in Heat Recovery System	yF	Low Liquid Level Switch Error
Lb	Inconsistency of Group-controlled Indoor Units in Reheat Dehumidification System	o0	Motor Drive Error
Ld	Indoor Fan 2 Error	o1	Low Voltage of IDU Bus Bar
Ln	Lift Panel Return Air Frame Reset Exception	o2	High Voltage of IDU Bus Bar
d1	Indoor Unit PC-Board Error	o3	IDU IPM Module Protection
d3	Ambient Temperature Sensor Error	o4	IDU Startup Failure
d4	Inlet Pipe Temperature Sensor Error	o5	IDU Overcurrent Protection
d5	Malfunction of Middle Tube Temperature Sensor	o6	IDU Current Detective Electric Circuit Error
d6	Outlet Pipe Temperature Sensor Error	o7	IDU Losing Step Protection
d7	Humidity Sensor Error	o8	IDU Driver Communication Error
d8	Water Temperature Abnormality	o9	Communication Error of IDU Master Controller
d9	Jumper Cap Error	oA	High Temperature of IDU Module
dA	Indoor Unit Hardware Address Error	oC	IDU Charging Circuit Error
dH	Wired Controller PC-Board Error	ob	Temperature Sensor Error of IDU Module
dC	Capacity DIP Switch Setting Error	—	—

10.3 Code List for Debugging

Error Code	Content	Error Code	Content
U2	Outdoor Unit Capacity Code/Jumper Cap Setting Error	C0	Communication between indoor unit and outdoor unit and the communication between indoor unit and wired controller have malfunction
U3	Phase Sequence Protection of Power Supply	C1	Communication error of expansion board
U4	Protection of Lack of Refrigerant	C2	Communication error between master control and inverter compressor drive
U5	Wrong Address of Compressor Drive Board	C3	Communication error between master control and inverter fan motor drive
U6	Valve Abnormal Alarm	C4	Error of Lack of Indoor Unit
U7	Grid DRED0 Response Protection	C5	Alarm of Indoor Unit Project Number Collision
U8	Indoor Unit Tube Malfunction	C6	Alarm of Wrong Number of Outdoor Unit
U9	Outdoor Unit Tube Malfunction	C7	Mode Exchanger Communication Error
UA	Overvoltage Protection of DC Bus Bar in Power Grid Side	CH	Rated capacity is too high
UH	Undervoltage Protection of DC Bus Bar in Power Grid Side	CC	No master control unit error
UC	Master indoor unit is successfully set	CL	Rated capacity is too low
UL	Emergency Operation DIP switch setting of the compressor is wrong	CE	Communication Failure Between Mode Exchanger and Indoor Unit
UE	Refrigerant Charging is ineffective	CF	Error of Multiple Master Indoor Unit

Error Code	Content	Error Code	Content
UF	Indoor Unit Identification Error of Mode Exchanger	CJ	System addresses is incompatible
UJ	PV module F0 protection	CP	Error of Multiple Master Wired Controller
UP	Protection shutdown error of thermal storage module	CU	Communication Error between Indoor Unit and Remote Receiver
UU	Electronic expansion valve leak error of thermal storage module	Cb	Outflow of Units IP Address
Ub	Protection without shutdown error of thermal storage module	Cd	Communication Failure Between Mode Exchanger and Outdoor Unit
Ud	Grid-connection driver board error	Cn	Indoor and Outdoor Network Error of Mode Exchanger
Un	Communication error between grid-connection driver board and master controller	Cy	Communication Error of No Master in Mode Exchanger
Uy	PV module overheating protection	—	—

10.4 Code List for Status

Error Code	Content	Error Code	Content
A0	Unit is waiting for debugging	Ay	Shielding status
A1	Check the compressor operation parameters	n3	Compulsory defrosting
A2	After-sales Refrigerant Reclaim	q5	Setting of ordinary units and high sensible heat units
A3	Defrosting	q7	Select degree Celsius or Fahrenheit
A4	Oil return	q8	Discharge low temperature protection revision value b
A5	Online Testing	q9	Setting of defrosting mode
A8	Vacuum-pumping Mode	qL	Setting of static pressure

Wired Controller XE70-33/H

Error Code	Content	Error Code	Content
A9	Operate in Setback Function	qE	EVI Operating Mode
AH	Heating	qF	System compulsory cooling mode
AC	Cooling	qP	PV GMV Unit export area setting
AF	Fan	qU	Grid voltage system configuration
AJ	Filter Clean Reminder	qb	Anti-condensation temperature setting
AU	Remote Urgent Stop	qd	Setting of target degree of super-cooling of ODU
Ab	Emergency Stop	qn	PV grid-connected settings
Ad	Operation Restriction	qy	Working mode of compressor heating belt
An	Lock status	—	—

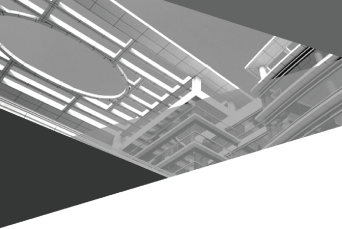

GREE ELECTRIC APPLIANCES, INC. OF ZHUHAI

Add: West Jinji Rd, Qianshan, Zhuhai, Guangdong, China, 519070

Tel: (+86-756) 8522218

Fax: (+86-756) 8669426

E-mail: global@cn.gree.com www.gree.com



600005060802