



SUBMITTAL DATA

DUC12HP230V1R32AH
12000 BTU/H Slim Duct (HS) Heat Pump System

Job Name	Location	Date
Purchaser	Engineer	
Submitted to	For	
Unit Designation	Schedule No.	

		
YBE1FB5F	DUC12HP230V1R32AH	XE72-44/E

GENERAL FEATURES

- AHRI Certificate: 215415562 (Vireo R32), 215415567 (Envo R32), 215415527 (Sapphire R32)
- High Efficiency DC Inverter Technology
- Compact and Quiet Design
- Slim Line Construction
- High Static E.S.P Capability -Adjustible
- Internal Condensate Drain Pump
- Flexible Return Air From Bottom Or Rear
- Wireless Remote with LCD Display Included
- XE72-44/E Wi-Fi Wired Controller Included
- Low Ambient Cooling and Heating
- Coil (Indoor and Outdoor) Copper Tube / Aluminum Fin
- Blue Colored Fin - 500 Hrs Salt Spray Tested
- New R32 Refrigerant with Refrigerant Sensor

SPECIFICATIONS, FEATURES & FUNCTION SUMMARY

INDOOR MODEL		DUC12HP230V1R32AH			
System Type		HEAT PUMP			
Outdoor Model		VIR12HP230V1R32AO	ENV12HP230V1R32AO	SAP12HP230V1R32AO	
SYSTEM PERFORMANCE					
Cooling	Min - Max	Btu/h	900 - 14,100	900 - 14,100	900 - 14,100
	Capacity @95°F	Btu/h	12,000	12,000	12,000
Heating	Min - Max	Btu/h	900 - 15,500	900 - 15,500	900 - 15,500
	Capacity @47°F	Btu/h	12,000	12,000	12,000
	Capacity @17°F	Btu/h	7,500	7,500	7,500
	Capacity Max @5°F	Btu/h	10,500	10,500	10,500
SEER2			21.0	21.0	22.0
EER2			13.0	13.0	13.0
HSPF2			9.0	9.0	9.0
COP @5°F			1.90	1.90	1.90
Cooling Temperature Range		°F		-20 - 122	
Heating Temperature Range		°F		-22 - 86	
Refrigerant Type				R32	
INDOOR UNIT		DUC12HP230V1R32AH			
Air flow (Min-Max)		CFM	212 - 353		
External Static Pressure (Max)		In W.c.	0.6		
Sound Pressure Level (Min - Max)		dB(A)	25 - 39		
Dehumidification		pt/hr	2.96		
External Dimensions (L x D x H)		in	32-43/64 x 29-11/16 x 11-13/16		
Package Dimension (L x W x H)		in	35-5/16 x 31-13/16 x 14-11/16		
Net Weight		lbs	70.6		
Gross Weight		lbs	83.8		
OUTDOOR UNIT		VIR12HP230V1R32AO	ENV12HP230V1R32AO	SAP12HP230V1R32AO	
Sound Pressure Level		dB(A)	52	52	55
External Dimensions (L x D x H)		in	31-37/64 x 13-25/32 x 21-27/32	31 37/64 x 13 25/32 x 21 27/32	34-3/8 x 14-51/64 x 21-27/32
Package Dimension (L x W x H)		in	34-21/64 x 15-43/64 x 24-13/32	34 21/64 x 15 43/64 x 24 13/32	37-7/16 x 16-31/32 x 24-13/32
Net Weight		lbs	67.3	70.6	78.3
Gross Weight		lbs	72.8	76.1	84.9
REFRIGERANT PIPING					
Refrigerant Charge - R410A		oz	28.2	28.2	47.6
Additional Charge		oz/ft	0.2	0.2	0.4
Line Set Sized by Indoor Unit (Liquid - Gas)		in		1/4 - 3/8	
Line Set Size (Liquid - Gas) - Flared Connections		in	1/4 - 1/2	1/4 - 1/2	1/4 - 1/2
Pre-Charge Length		ft		25	
Pipe Length (Min - Max)		ft	10 - 66	10 - 66	10 - 131
Max. Pipe Elevation		ft	40	40	82
ELECTRICAL					
Power Supply		208-230V / 1Ph / 60Hz (Powered by the Outdoor Unit)			
Voltage Range (Min - Max)		VAC	187 - 253		
Rated Current - Cooling		A	6.64	6.64	5.9
Rated Current - Heating		A	6.41	6.41	7.8
MCA		A	10	10	11
MOCP		A	15	15	15
Suggested Breaker Size		A	10	10	15
Main Power Wire Size		AWG	Per Local Code		
Interconnecting Wire Size		AWG	14 / 4		

FEATURES & FUNCTIONS SUMMARY

SYSTEM FEATURES

Inverter Type	G20 with Field Oriented control (FOC)
Ultra Low Frequency Torque Control	Yes
Power Factor Correction	Yes
Compressor Type - Inverter	High Efficiency Rotary
Basepan With Electric Heater	Yes
Indoor & Outdoor Fin Coating (Blue Fin)	Yes
Intelligent Defrosting	Yes
Intelligent Preheating	Yes
Low Voltage Startup	Yes
Memory/Power Failure Recovery	Yes
Self Diagnosis	Yes
Wired Controller Interface	Yes
WiFi Included	No
Indoor Fan Type	Centrifugal
Multi Fan Speeds	4 Speeds
Indoor Unit Display	Yes
Auxiliary Electrical Heater	No
Ventilation (Outdoor Air)	Yes

NOTE:

Please check the Multi-zone submittals for Ducted or Mixed Performance table.

FAN PERFORMANCE

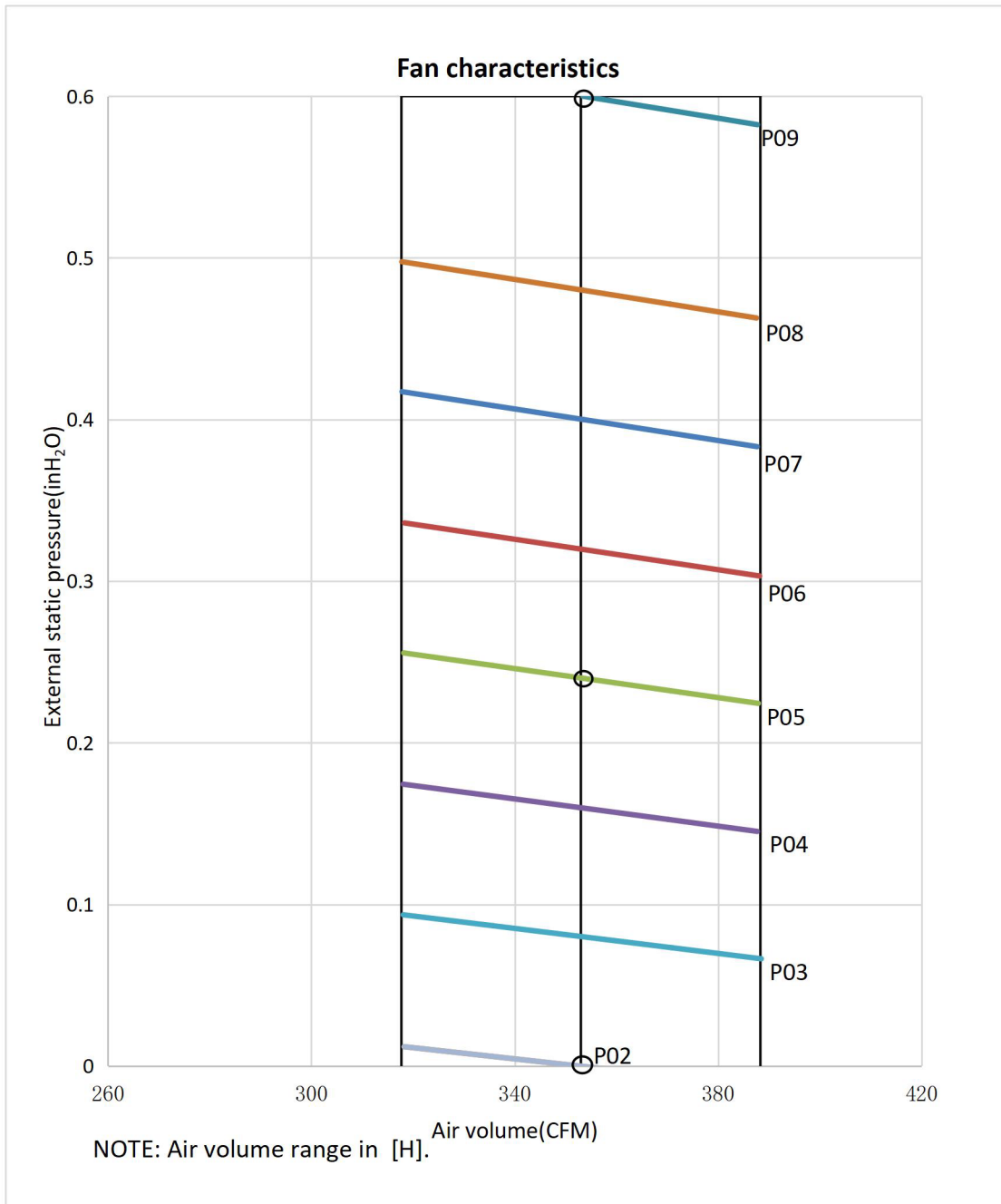

NOTE:

The static pressure is adjusted using the wired controller. Refer to the wired controller instruction manual for more information.

DIMENSIONS

INDOOR UNIT

Unit: inch

DUC12HP230V1R32AH	
DIMENSIONS	
A	29 9/64
B	19 11/16
C	32 43/64
D	11 13/16
E	29 11/16
F	27 9/16
G	27 9/16

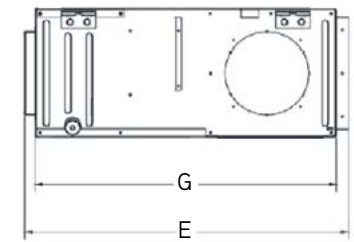
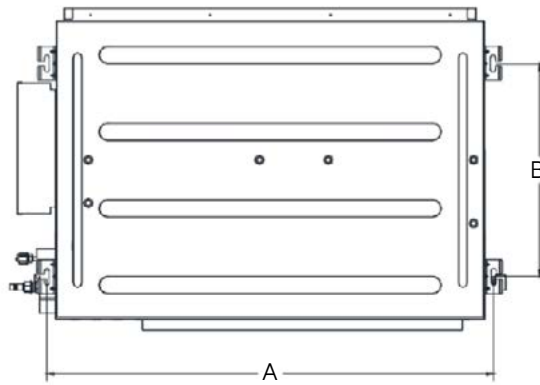
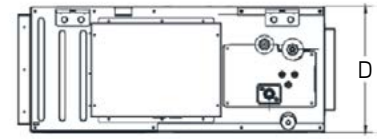
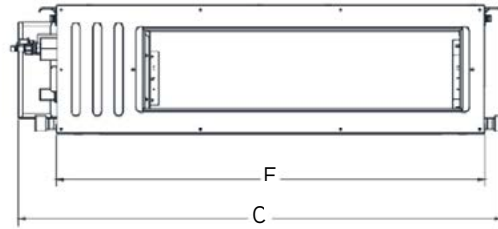

OUTDOOR UNIT

Unit: inch

VIR12HP230V1R32AO	
DIMENSIONS	
A	29 21/64
B	31 37/64
C	21 27/32
D	11 13/16
E	13 25/32
F	20 5/32
G	13 5/64

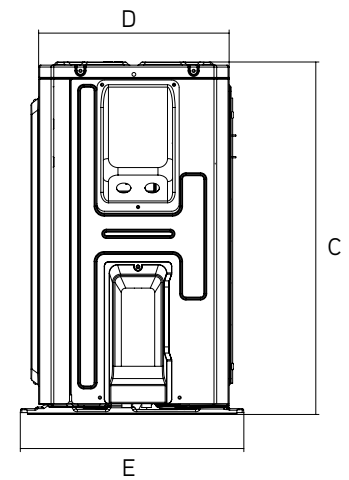
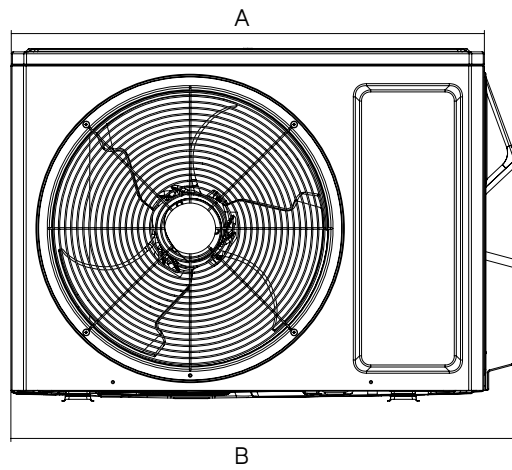

ENV12HP230V1R32AO	
DIMENSIONS	
A	29 21/64
B	31 37/64
C	21 27/32
D	11 13/16
E	13 25/32
F	20 5/32
G	13 5/64

SAP12HP230V1R32AO	
DIMENSIONS	
A	31 11/16
B	34 3/8
C	21 27/32
D	13 1/64
E	14 51/64
F	20 25/32
G	13 21/32

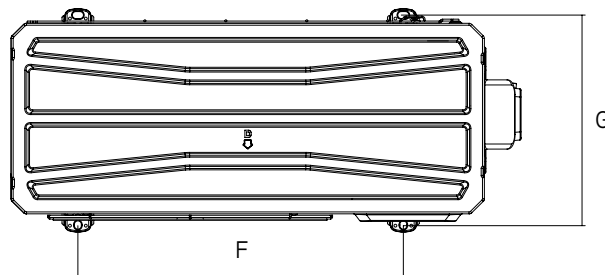

SUPPLY AND RETURN AIR OPENING DIMENSIONS

SUPPLY AIR OUTLET

Unit: inch

DUC12HP230V1R32AH	
DIMENSIONS	
A	7-5/8
B	17-3/4
C	1

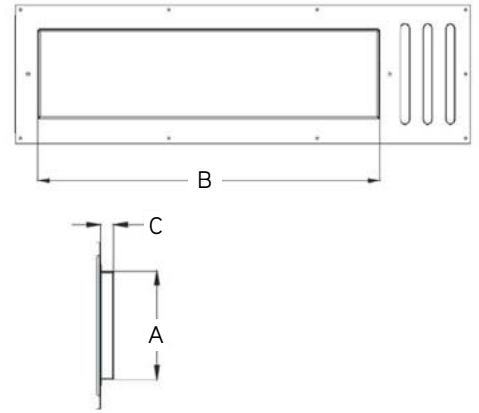
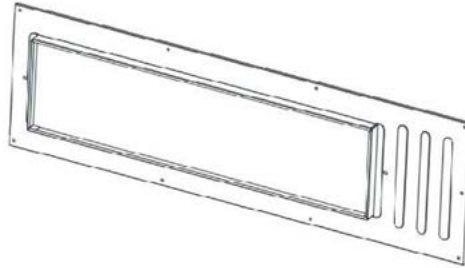

RETURN AIR INLET

Unit: inch

DUC12HP230V1R32AH	
DIMENSIONS	
D	10-3/8
E	26
F	1-1/8

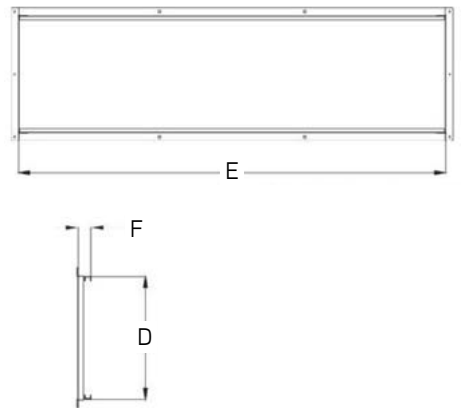
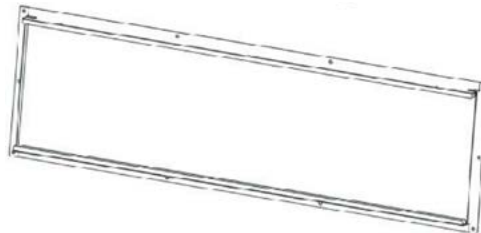

CLEARANCES

INDOOR UNIT

Minimum clearance

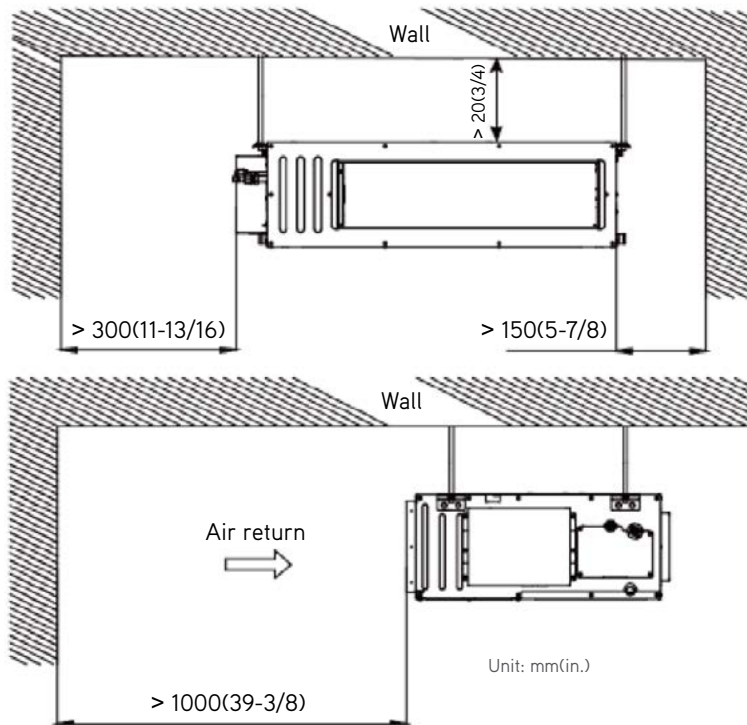

OUTDOOR UNIT

Minimum clearance

NOTE:
If bottom of the unit is free of airflow obstructions similar to the mounting bracket figure, the clearance to the wall on the back can be reduced to 3 inches.

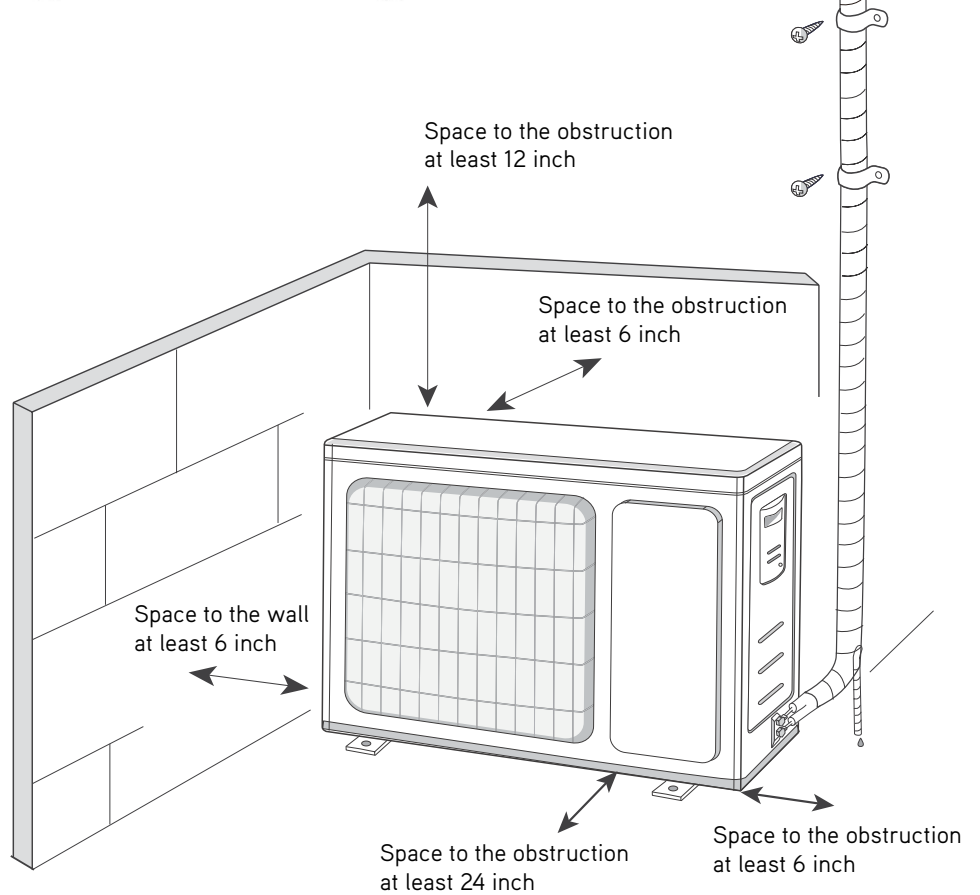

Specifications are subject to change without notice. Manufacturer reserves the right to discontinue or modify specifications or designs without notice or without incurring obligations. All Rights reserved.