

208~230V Floor Ceiling

Model:GMV-ND24ZD/A-T(U)



Specifications	Unit	Parameter
Model	—	GMV-ND24ZD/A-T(U)
Performance		
Rated Cooling Capacity	kBtu/h	24
Rated Heating Capacity	kBtu/h	27
Sound Pressure Level	dB(A)	39/42/44
Electrical Data		
Power Supply	Voltage,Phase, Hertz	208/230,1,60
Maximum Overcurrent Protection (MOP)	A	15
Minimum Circuit Amps (MCA)	A	1
Fan		
Type x Quantity	—	Centrifugal×3
Air Flow Volume	CFM	640/675/825
Fan Motor Running Current	A	0.55
Fan Motor Power Output	W	150
Refrigerant Piping		
Connection Pipe	Gas(mm/inch)	Φ15.9/Φ5/8
	Liquid(mm/inch)	Φ9.52/Φ3/8
Connection method	—	Flare Connection
Refrigerant	—	R410A
Dimension/Weight		
Dimensions (H×W×D)	mm/inch	245×1420×700/ (9-5/8×55-7/8×27-9/16)
Net Weight	kg/lbs	50/110
Other		
Safety Certification	—	ETL

Job Name:		Date:	
System Reference No.:			
Engineer Signature:			

Outline and Physical Dimensions of GMV-ND24ZD/A-T(U).

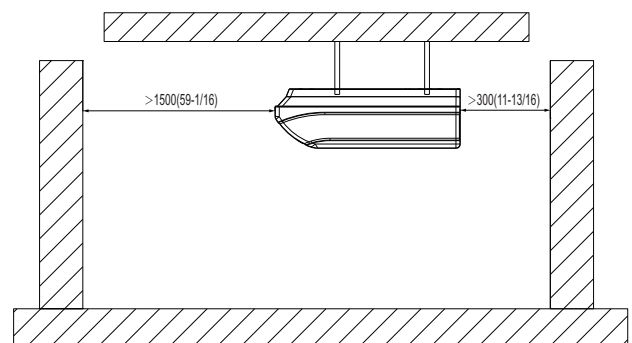
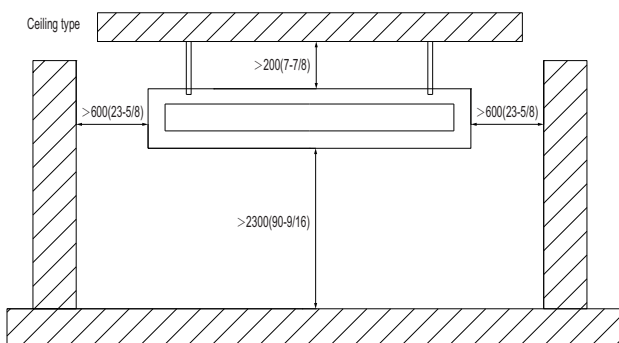
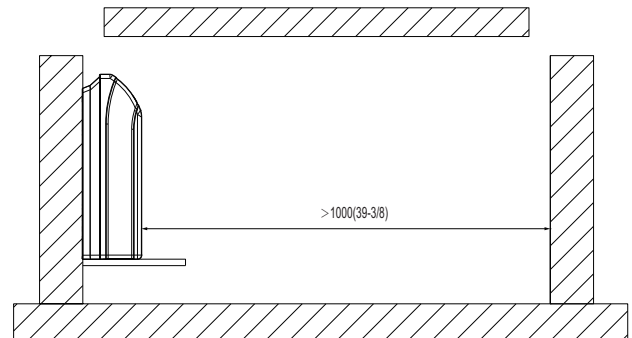
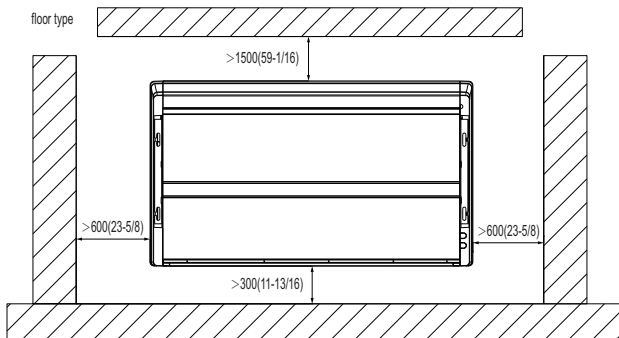
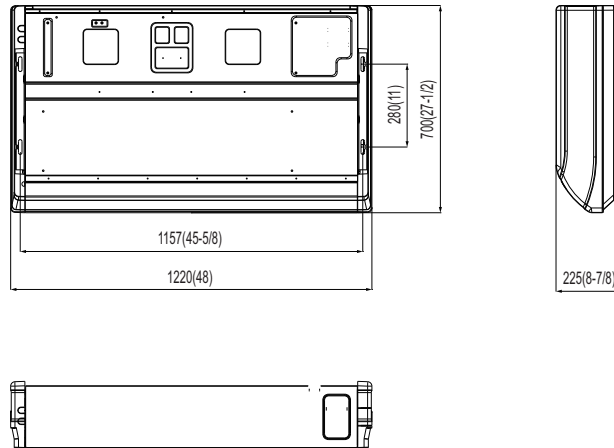

Unit:mm(in.)

