



Air comfort for all

MULTIPRO

QUICK START GUIDE

Heat Pump

Thank you for choosing our product.
Please read this Quick Start Guide carefully before
operation and retain it for future reference.

To download an electric version of this manual visit
www.greecomfort.com/multipro-quick-start-guide

PLEASE READ FIRST

NOTE

- This document does not apply to Ultra Heat "B" Models (GMV-XXWL/B-T(U))

Although like Mini-Split heat pump systems, MultiPRO Heat Pump Systems have key installation differences.

- Line Voltage Power Supply to Indoor and outdoor units are separate circuits.
- Service disconnects at each indoor unit, units without heater kits can use a two-pole toggle switch.
- Communication wire is 18-2 stranded wire.
- Indoor connected capacity requirement is 50 to 135 % of the outdoor unit capacity.

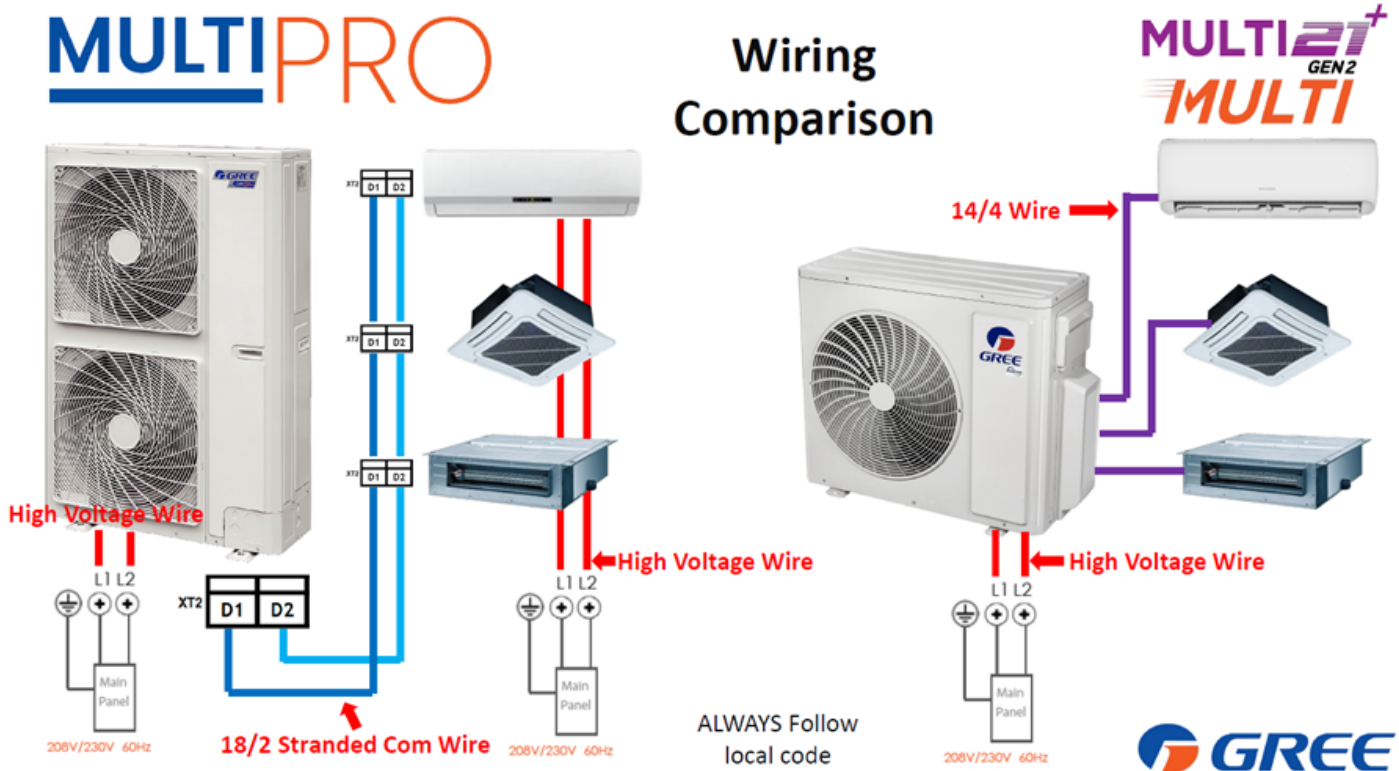

⚠ DO NOT DISCARD. STORE THIS INFORMATION IN A SAFE PLACE FOR FUTURE REFERENCE.

COMMUNICATION WIRING

- All control wiring is 18 AWG, 2-Conductor, Stranded
- Shielding is not required, but if used, must tie together, following the daisy chain (parallel) configuration of the control wiring, and grounded only at the outdoor unit

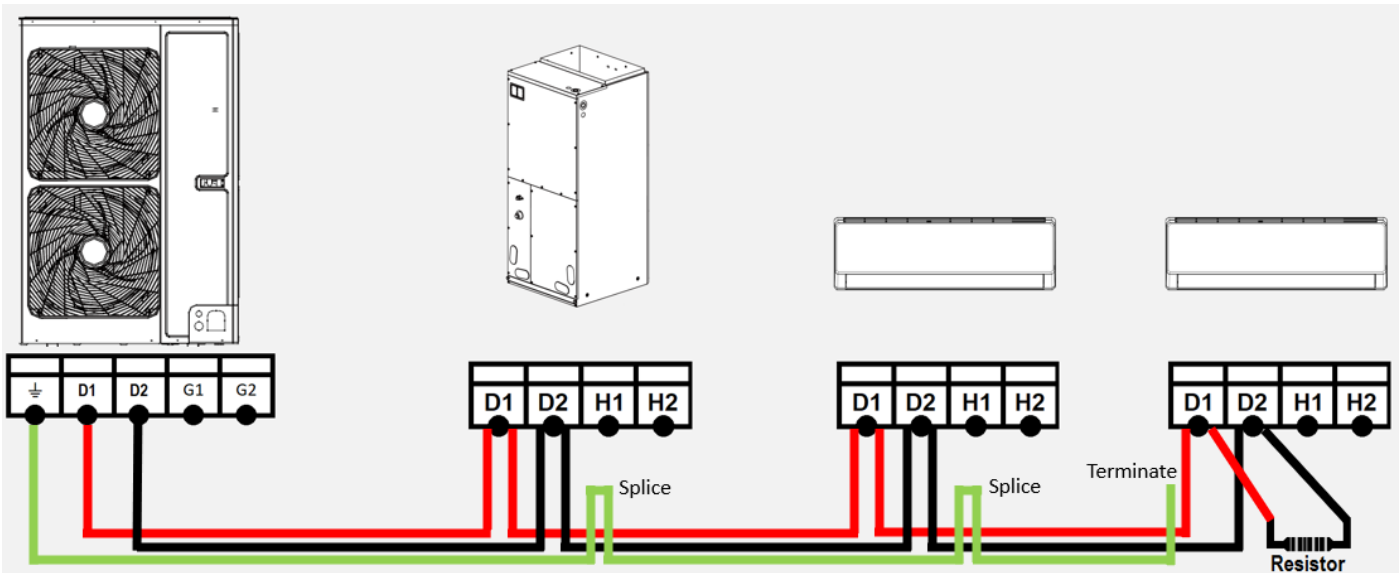
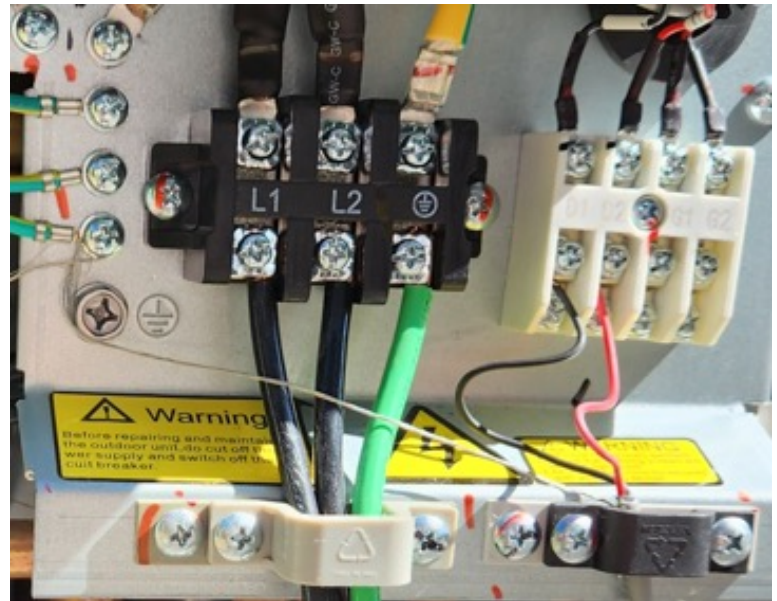
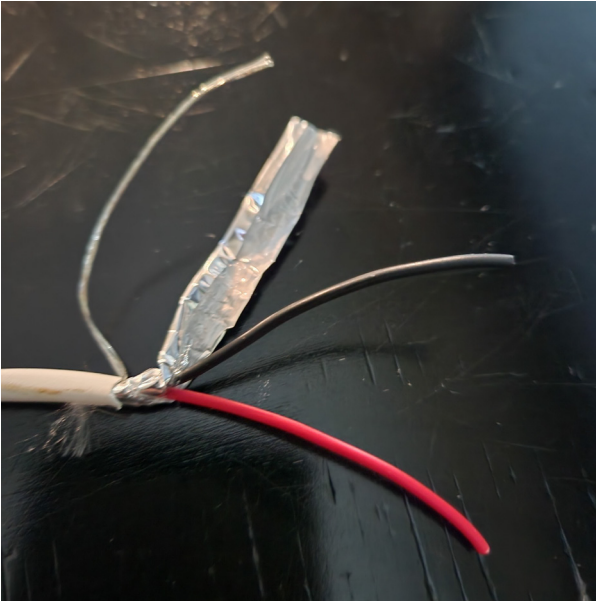

- 120 ohm ¼ watt resistor is shipped with outdoor unit and is connected at the last indoor unit

AUTO ADDRESS

NOTE

- Indoor Units will auto address randomly selecting the Main Indoor Unit
- Main Indoor unit can be changed using the wired controller or wireless remote.

Setting the Main indoor unit

- For wired controllers, set the Main indoor unit within the controllers settings menu
- For wireless controllers:
 1. Set Mode to Fan
 2. Set Temp to 86°F or 30°C Press Down/Up 3 times quickly. UC will display on indoor unit; this sets the unit to be the main unit.

CONTROLLER WIRING

- Wired Controller wiring 18/2 stranded
- Connects to H1/H2 terminals on corresponding indoor unit
- Can control multiple indoor units when wired in a daisy chain configuration as shown below

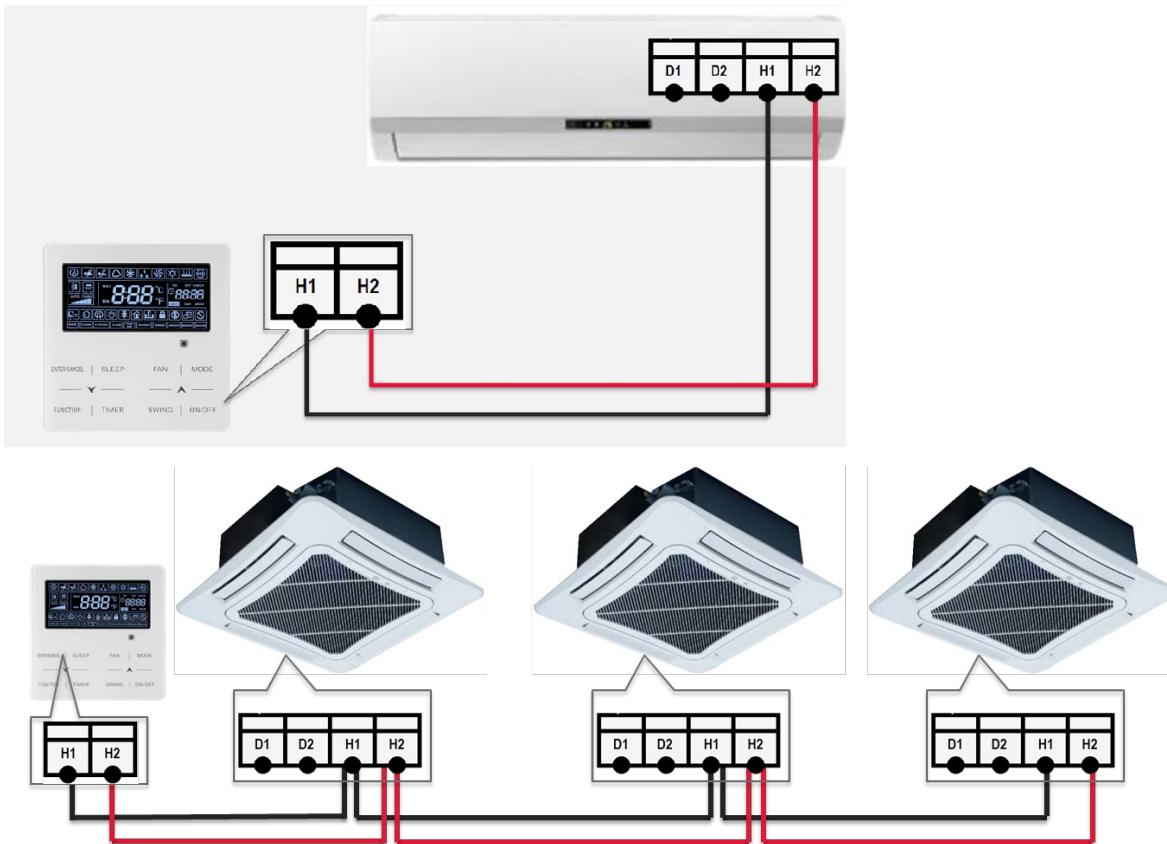

- Controller needs to be set to control multiple units. Refer to Controller Installation Instructions.

WALL MOUNT CONTROLLER CONNECTION

- H1 H2 Wired Controller Connections
- Remove Black Molex
- Connect H1 and H2 to the Yellow and White wires

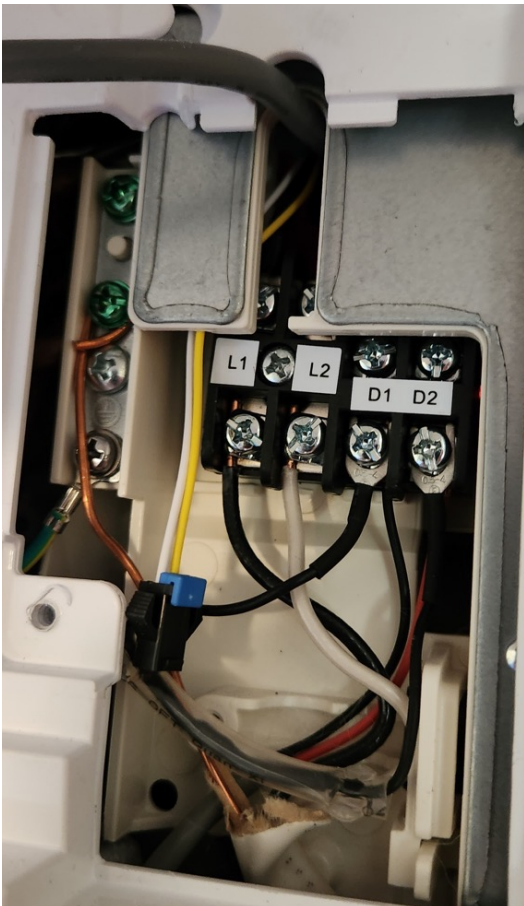

CENTRAL CONTROL / COOLAUTOMATION WIRING AND ADDRESS SET UP

NOTE

- This only applies if there is more than one Condenser that will have a Central Controller or has CoolAutomation.

- Before Applying power to the Condenser
- Make sure G1 and G2 are wired in daisy chain between outdoor units.
- Set dip switches on outdoor units
- This should done before start up even if Central Control or Automation is not being connected until a later date.

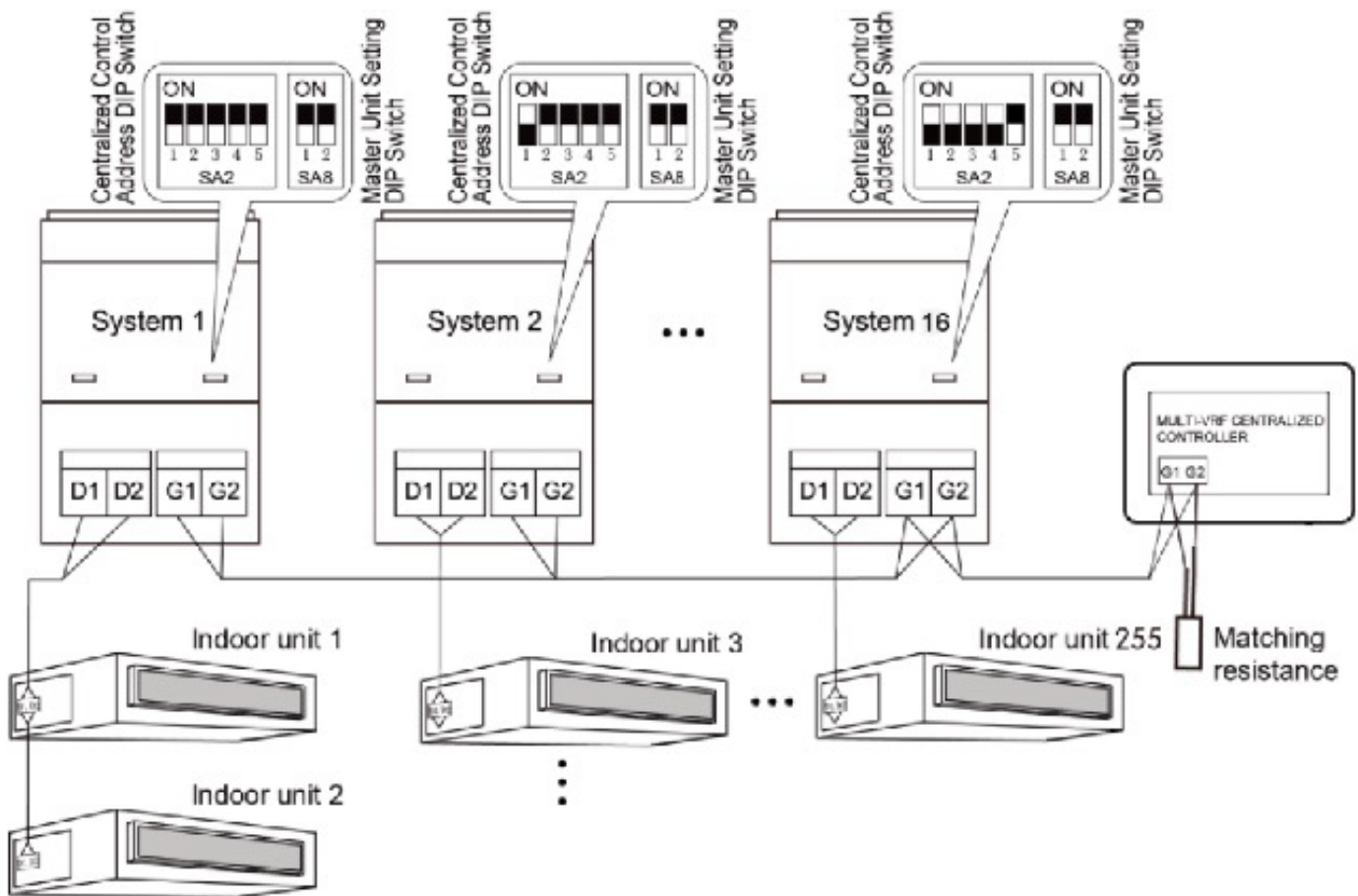

1 = OFF

0 = On

Dip switches are located on the main board of the condenser

Address one is default, all dip switches on.

SA2					Address NO.
DIP1	DIP2	DIP3	DIP4	DIP5	
1	0	0	0	/	2
0	1	0	0	/	3
1	1	0	0	/	4
0	0	1	0	/	5
1	0	1	0	/	6
0	1	1	0	/	7
1	1	1	0	/	8
0	0	0	1	/	9
1	0	0	1	/	10
0	1	0	1	/	11
1	1	0	1	/	12
0	0	1	1	/	13
1	0	1	1	/	14
0	1	1	1	/	15
1	1	1	1	/	16

REFRIGERANT PIPING INSTALLATION GUIDELINES & DESCRIPTIONS

Refrigerant Piping

- Heat Pump has two pipes, liquid and gas
- Both must be insulated
- System mode is set by a user-determined Main indoor unit
- Twenty inches must be maintained between elbows, headers, and Y-Branches

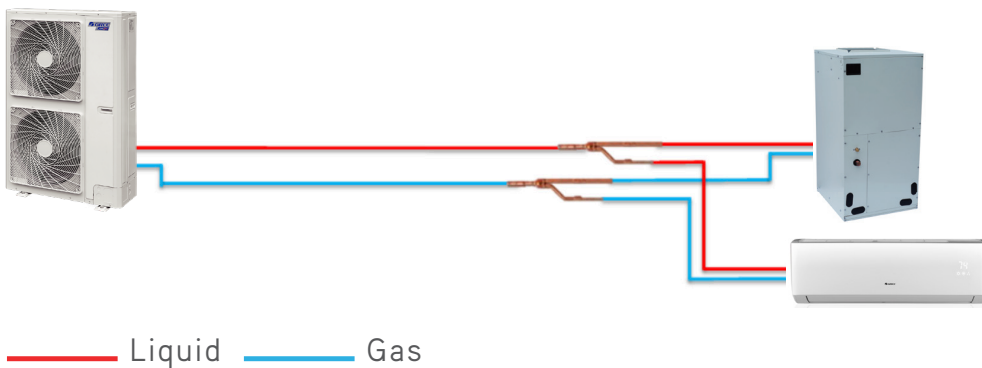

Y-Branches

- Specially designed for even distribution of refrigerant
- Each kit includes one Y-Branch for gas and one Y-Branch for liquid
- Simply use a tubing cutter for larger line sets
- If installed horizontally, they must be level
- If installed vertically, they must be plumb
- FQ01A/A is used for downstream capacities of less than 68kBtu
- FQ01B/A is used for downstream capacities of more than 68kBtu

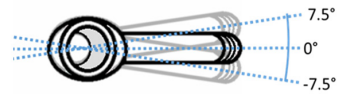
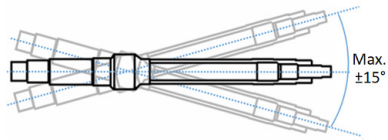
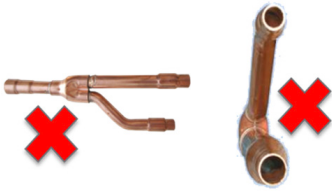

Headers

- Specially designed for even distribution of refrigerant and oil
- Each kit includes one Header for gas and one Header for liquid
- Simply use a tubing cutter for larger line sets
- Must be installed horizontally and they must be level
- Liquid header is built with downward facing offset for installation next to gas header
- FQ14/H1 is used for 4 units or less
- FQ18/H1 is used for 8 units or less

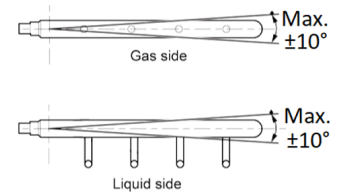
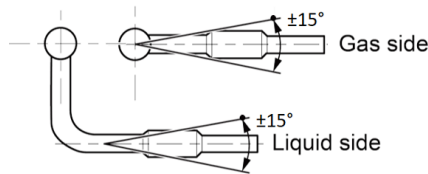
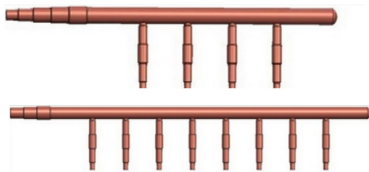

SINGLE ZONE

Single Zone Piping Limits	2 and 2.5T	3, 4, and 5T	3, 4, and 5T
	Standard	Standard	Ultra
Max Length ODU to IDU: (Actual)	328'	394'	213'
Max Height ODU Above IDU:	98'	164'	164'
Max Height ODU Below IDU:	98'	131'	131'

Single Zone MultiPRO		
The piping sizes are determined by ODU		
Model	Liquid	Gas
2 Ton Outdoor Unit	3/8"	5/8"
2.5 Ton Outdoor Unit	3/8"	5/8"
3 Ton Outdoor Unit	3/8"	5/8"
4 Ton Outdoor Unit	3/8"	5/8"
5 Ton Outdoor Unit	3/8"	3/4"

If necessary, reduce the piping size at the indoor unit

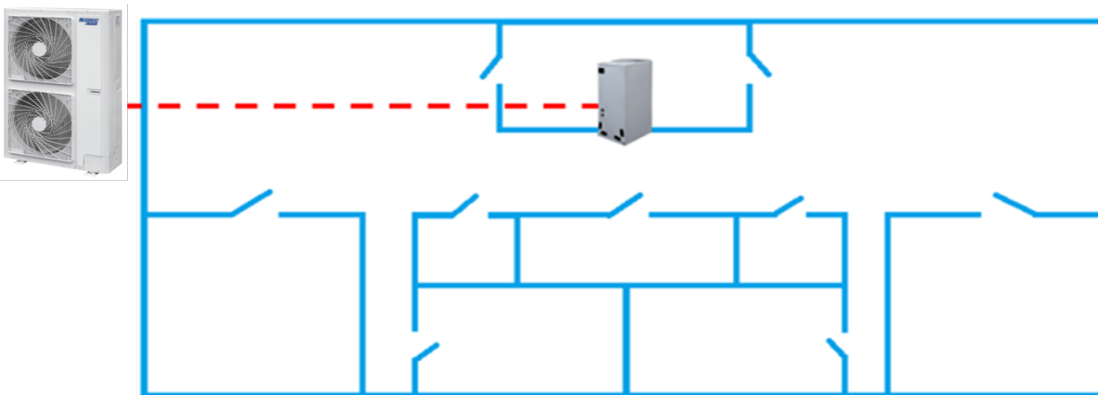

DUAL AND MULTI ZONE MULTIPRO

Dual/Multi Zone Piping Limits	2 and 2.5T	3, 4, and 5T
Max Length IDU to Y-Branch or Header:	98'	98'
Max Length IDU to Y-Branch or Header:	50'	50'
Max Height ODU Above IDU:	98'	98'
Max Height ODU Below IDU:	98'	98'

Note: these are basic limitations. Actual limitations are far greater. Use MultiPRO System Builder, MultiPRO Selector, or see installation manuals for more details.

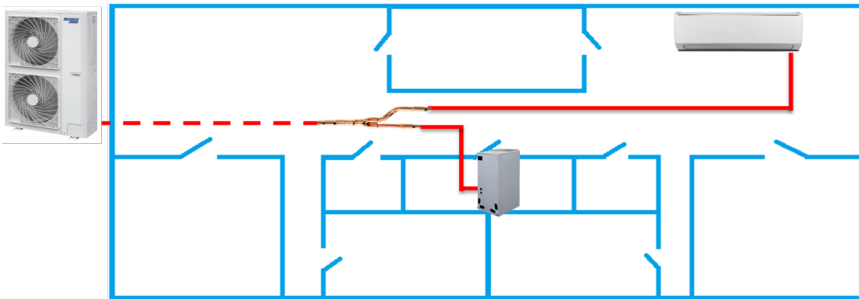

Dual and Multi Zone MultiPRO					
Model	Liquid	Gas	Model	Liquid	Gas
2 Ton Outdoor Unit	3/8"	5/8"	5 to 9kBtu	1/4"	3/8"
2.5 Ton Outdoor Unit	3/8"	5/8"	12 to 15kBtu	1/4"	1/2"
3 Ton Outdoor Unit	3/8"	5/8"	18 to 48kBtu	3/8"	5/8"
4 Ton Outdoor Unit	3/8"	5/8"	54 and 60kBtu	3/8"	3/4"
5 Ton Outdoor Unit	3/8"	3/4"	Above 60kBtu	N/A	N/A

If necessary, reduce the piping size at the indoor unit.

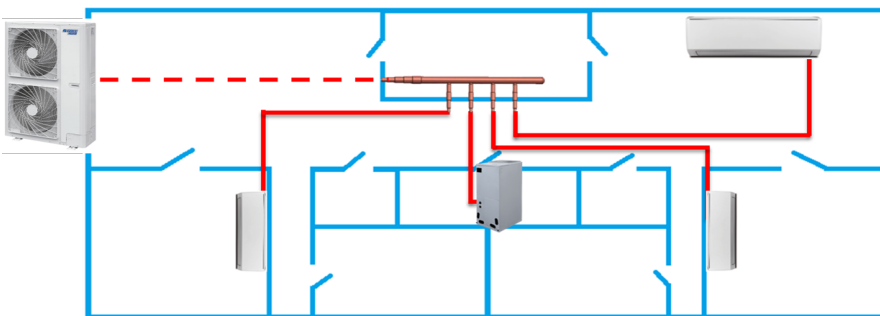

GMV-VXXWL/C-T(U) Ultra Units all have 3/4" Gas Pipe Service Valves

- 3- and 4-Ton Use 5/8" Gas Pipe
- 5 Ton Uses 3/4" Gas Pipe
- Using the Provided Dog Legs will allow connection to 5/8" or 3/4" pipe.



GMV-VXXWL/C-T(U)

Have compressor shipping brackets that must be removed.

This instruction is under the front panel of the unit.

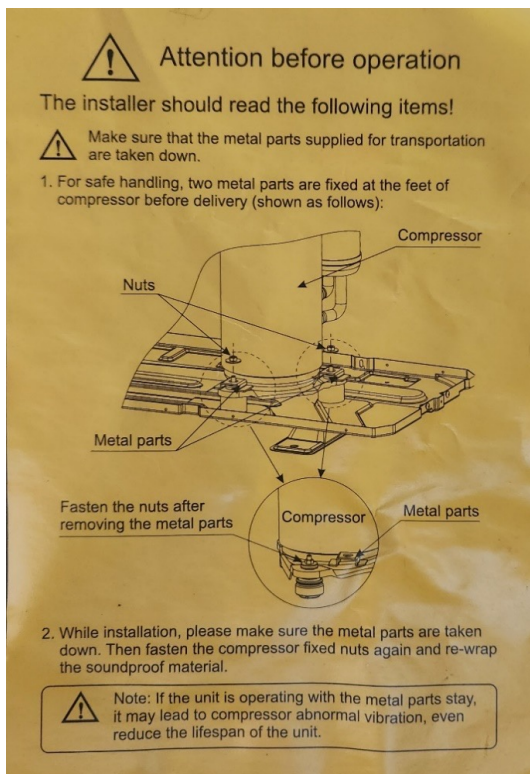

NITROGEN PRESSURE TEST

- Once piping is complete, pressure test the system through both service valves
- Start at 150 psi and hold for 3 minutes
- Increase to 325 and hold for 5 minutes
- Increase to 500 and hold for 1 hour

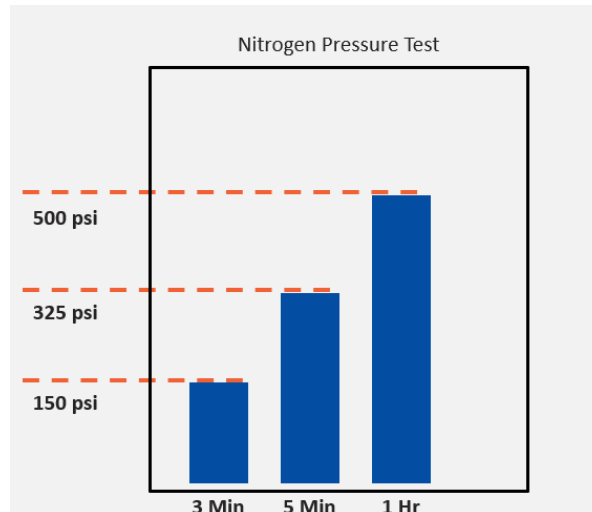

EVACUATION

- Use a Micron Gauge
- Connect to Liquid and Gas
- Triple Evacuation is recommended
 - Ensures dry system
 - Often quicker
- Pull down to 4000 microns
 - Hold for 15 minutes
 - Break with 3 psi of Dry Nitrogen
 - Hold for 20 minutes
- Pull down to 1500 microns
 - Hold for 20 minutes
 - Break with 3 psi of Dry Nitrogen
 - Hold for 20 minutes
- Pull down to 500 microns
 - Hold for 1 hour
 - Does not rise above 1000 microns

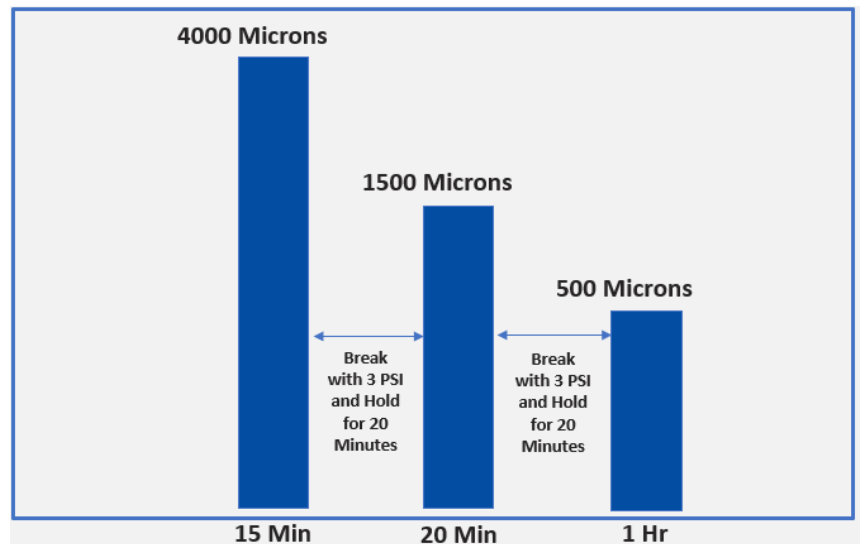

ADDITIONAL REFRIGERANT CHARGE

For These Models

- GMV-24WL/C-T(U)
- GMV-28WL/C-T(U)
- GMV-36WL/C-T(U)
- GMV-48WL/C-T(U)
- GMV-60WL/C-T(U)

- Use only the liquid line for calculating additional refrigerant charge.
- Only 1/4" and 3/8" are used.
- Multiply each length by the ounces per foot in the chart!
- 10.5 ounces per indoor unit over two. If two or less, ignore this additional amount.
- Add the total for 1/4", the total for 3/8" and the indoor unit amount.

- Length of 1/4" times 0.24 Oz per Foot
- Length of 3/8" times 0.58 Oz per Foot
- Add those two numbers together.
- Add 10.5 Ounces per IDU over two

Example:

	Quantity	Multiply	Subtotal
Total Liquid Line Length of 1/4" :	45'	.24	11oz
Total Liquid Line Length of 3/8":	18'	.58	10oz
Total Number of Indoor Units (Subtract 2):	3	10.5	10.5oz
Total Additional Refrigerant Charge:			31.5oz

These models must use system builder or selection software for additional charge amount.

- GMV-V36WL/C-T(U)
- GMV-V48WL/C-T(U)
- GMV-V60WL/C-T(U)

START UP

- Power on all indoor units
- All should display AO on unit display and/or wired controller
- Units without a display likely don't have power
- Any units displaying CO, have a communication error

DEBUG PROCESS

- Locate the four buttons on the outdoor board SW1 through SW4
- Note the display. It will cycle status codes.
 - Likely says OF and AO
- Note the display. It will cycle status codes.
 - Likely says OF and AO
- Press and hold SW3 for 5 seconds
 - Displays 01 and ON
- Do nothing until 04 is flashing
 - Number of indoor units
 - If it matches, press SW3
 - If it doesn't, check indoor units

Please note: The display may only show a steady "04" if four indoor units are communicating.
- Unit continues until 10
 - Unit starts and checks if shutoff valves are open
- When the display reads 12 and AP (flashing)
 - If additional refrigerant still needs to be added be prepared to add charge before moving forward.
 - Press SW3

- Unit now displays 15 and AC for cooling or 16 and AH for heating
 - Mode of operation is determined by outdoor ambient
 - System is calibrating itself based on number of indoor units and piping lengths
- System will operate for 45-60 minutes
 - Ignore pressures and temperatures during this time
- Once complete, the outdoor display will say OF meaning off and the indoor units will be off.

COLD WEATHER START UP



In Cold Weather, Compressor must warm up before system start-up.

Connect power to Outdoor Unit as instructed below.

Above 50°F = 1 Hour

32°F - 50°F = 2 Hour

14°F - 32°F = 4 Hour

Below 14°F = 8 Hour

As reference, use the coldest temperature in the last 24 hours.



- If Debug stops at 08 and U0
- This means compressor has not had 8 hour warm up.
- The unit can be allowed to finish debug provided compressor warm up rules are met.
- To Confirm Press SW3 1 time

DUCTED UNIT BLOWER STATIC SETTING

Fan static is a parameter setting 1 – 9 in the wired controller default is 5. Making these adjustments will verify airflow is acceptable and will allow the blower to modulate speed in Auto mode. Refer to controller owner's manual for static adjustment.

Fan Static Setting of the Controller sets the max speed the blower can run at.

Total Static is measured to verify fan static is correctly set

SUGGESTED SET UP:

1. Leave Fan static set to default of 5 on the controller. Turn fan speed on the controller to high speed, then measure the static pressure using a Magnehelic or digital manometer.
2. If the total static is .4 to .5 then the factory setting does not need to be adjusted.
3. If the total static pressure is .3 or below, then the fan static setting needs to be lower so that the unit does not deliver more air than it needs to.
4. If the total static is .6 to .7 then adjust the fan static setting to 6 or 7 and recheck static pressure and make did not increase over .9
5. 5. If the fan static is .8 or higher increasing the static pressure setting will only increase the total static to .9 or higher therefore make sure all registers are open and make necessary ductwork modifications to lower the total static pressure.

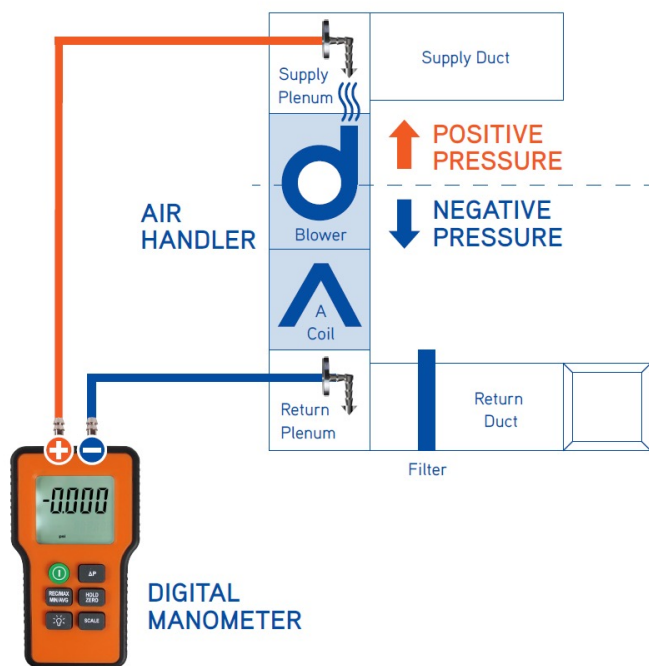

MAIN UNIT EXPLANATION

- The Main indoor unit determines the mode for the system
- All other indoor units will not be able to select the opposite mode
- With wired controllers, this means that the opposite mode will not display
- With handheld remotes, the opposite mode will cause the unit to sound a double-beep, indicating an invalid setting
- Indoor units already cooling or heating will switch modes based on the Master setting
- The setpoints will continue to be maintained



Air comfort for all

U.S. CONTACT INFORMATION TRADEWINDS, LLC

E-mail: info@twclimate.com

Contractor Support: 888-850-7928 | Mon-Fri 8 AM - 5 PM EST

GREECOMFORT.COM
